

# TiLite AERO Z Order Form

Effective January 1, 2012 (New Items in Red)

ALUMINUM RIGID FRAME

Page 1 of 9

DEALER INFORMATION		RTS INFORMATION		
Dealer:		RTS:	Phone:	
Account:	PO:	Email:		
Ordered By:		SHIP TO INFORMATION		
Address:		Name:	Ship Via:	
City:	State:	Zip:	Address:	
Phone:	Fax:	City:	State:	Zip:
Email:		Phone:	Fax:	
Mark For:		TiLite Information	Promo Code:	
		Ship Date:	Order #:	

Please Fax to the TiLite Customer Service Team at 866.586.2413 or 509.586.2413



Black Lava TiLite Aero Z shown with Ultraviolet Color Anodize Package and other available options.

## FRAME STYLE

A2FS2  **TiLite Aero Z** (Full Adjustability) (265 Pound Weight Limit. For Rear Seat Width **A** and Seat Depth **B** of 15" or greater, use K0005. For Rear Seat Width **A** and Seat Depth **B** of less than 15", use E1229. Weight Limit is restricted to 150 pounds on chairs with Rear Seat Width **A** and Seat Depth **B** from 10"x10" to 12"x12".)..... \$2,095 **K0005**

**TiLite Special Editions** If selecting one of the TiLite Special Editions you must still fill out the entire order form. Edition options will override inconsistent selections. Options cannot be added or deleted.

### A2P1 SuperLite Edition

- A2FTR1 Titanium Footrest w/Flat ABS Cover..... \$150
  - A2SB2 Folding Titanium Backrest..... \$175
  - A2SB7 Carbon Fiber TiShaft™ Back Release Bar..... \$65
  - A2CBR6 Carbon Fiber Camber Tube (Not available with a Power Adaptable Frame. When a Power Adaptable Frame is selected, a Titanium Camber Tube will be used.)..... \$175
  - A2FF2 TiLite Slipstream Single-Sided Fork..... \$150
  - A2TS1 Titanium Fork Stems..... \$50
- Retail: \$765**  
**SuperLite Edition Price: \$650**

### A2P2 Active Edition

- A2FTR1 Titanium Footrest w/Flat ABS Cover..... \$150
  - A2CBR3 Titanium Camber Tube..... \$50
  - Carbon Fiber Side Guards**
  - A2SDG8 Fold Down Rigid..... \$400
  - OR**
  - A2SDG9 Fendered Removable..... \$375
- Retail: \$575 - \$600**  
**Active Edition Price: \$490**



THE ULTIMATE RIDE.®

tilite.com  
2701 West Court Street | Pasco, Washington 99301  
509.586.6117 Tel | 800.545.2266 Toll-Free  
509.586.2413 Fax | 866.586.2413 Toll-Free Fax

## FRAME STYLE

A2P3  **Rugged Edition** (Requires 14.5" minimum Rear Seat Height **D**.)

- A2CBR3 Titanium Camber Tube.....\$50
- A2RW3 Spinergy SPOX Rear Wheels .....\$695
- A2RTR5 24", 25" or 26" Kenda® High Pressure (110psi).....\$95

**AND**

- A2RW2 TiLite Rear Wheels w/High Flange Hub .....\$225
- A2RTR6  24" Grey Knobby **OR** A2RTR7  26" Black Knobby.....\$95
- A2AXL4 Additional Set of Stainless Quick Release Axles .....\$65

**Retail: \$1,225**

**Rugged Edition Price: \$999**

A2P4  **Armed Forces Edition** (Armed Forces Edition can be ordered in combination with any of the other Frame Styles. Satin or Polished Natural Titanium Finishes may also be selected with Armed Forces Edition. Neoprene Impact

Guards will match Digital Camo when ordered.).....\$140

- A2AF1  Army (Subdued Green painted frame with ACU digital upholstery.)
- A2AF2  Navy (Subdued Dark Blue painted frame with NWU digital upholstery.)
- A2AF3  Air Force (Subdued Green painted frame with New ABU digital upholstery.)
- A2AF4  Marines (Subdued Tan painted frame with MARPAT - Desert digital upholstery.)
- A2AFP1  4" Logo Patch **OR** A2AFP2  Name Tape Patch
- A2AFP3  Combat Wounded Purple Heart Patch

A2PWR1  **Power Adaptable Frame** (No charge when 20" Rear Seat Width **A** and 20" Seat Depth **B** are selected. Requires Billet Aluminum Front Wheels and 0° Camber **F**. Not available with Carbon Fiber or Titanium Camber Tubes or Titanium Quick Release Axles. Camber Tube available in silver anodize only.) .....\$300

A2RFR1  **Reinforced Frame** (No charge when 20" Rear Seat Width **A** and 20" Seat Depth **B** are selected.) .....\$300

## WHEELCHAIR TRANSPORT BRACKETS

A2WTB  **Wheelchair Transport Bracket Option** (Consists of four factory-installed wheelchair transport brackets. Unoccupied Use Only.).....\$250

**THIS SECTION MUST BE READ**

The TiLite Aero Z Series 2 with Wheelchair Transport Bracket Option (A2WTB) was NOT crash-tested in accordance with ISO 7176-19 or ANSI/RESNA WC19. Therefore, the Wheelchair Transport Bracket Option is intended ONLY to secure an unoccupied wheelchair in a motor vehicle. The U.S. Department of Transportation has not approved any tie-down system for transportation of a user while in a wheelchair in a moving vehicle of any type. It is TiLite's position that users of wheelchairs should be transferred into appropriate seating in motor vehicles and use the restraints made available by the auto industry.

## FRAME FINISHES

**Natural Aluminum**

A2FF1  Light Satin (Finished with clear powder coat.) .....**STD**

A2FF3  **Tattooed Aluminum™** (Tattoos on front frame tubes. Finished with clear powder coat. Click on the images below to view the Tattoos online.).....**\$295**

A2FF4  Rock & Roll

A2FF5  Retro



A2FF6  Mother Nature



A2FF7  Henna



**High Gloss Paint**

- A2FF8  Super Wet Black
- A2FF11  Military Green

- A2FF9  Sunburst Yellow
- A2FF12  Orange Crush

A2FF10  TiLite Red

**Metallic Paint**

A2FF14  Ocean Blue Metallic

A2FF15  Tangerine Metallic

A2FF13  Hot Pink

**Pearlescent Paint**

A2FF17  Midnight Blue Pearl

A2FF18  White Pearl

A2FF16  Salsa Red Metallic

**Matte Paint**

A2FF19  Black Lava

A2FF20  Deep Blue Ice

A2FF21  Scarlet Ice

A2FF27  Titanium Grey

**Candy Paint**

A2FF22  Ruby Red

A2FF23  Azure Blue

A2FF24  Root Beer Candy

A2FF25  Electric Plum

A2FF26  Atomic Green .....**STD**

## COLOR ANODIZE PACKAGE

(Color Anodize Package includes: Aluminum Camber Tube, Camber Mount, Caster Mount, Caster Fork, and Caster Caps. If no anodize color is selected, the default will be black.)

A2ANO1  Black .....**STD**

A2ANO5  Sapphire A2ANO3  Red Pepper A2ANO6  Burnt Orange A2ANO7  Sub-Lime A2ANO8  Ultraviolet .....**\$125**

**FRAME MEASUREMENTS**

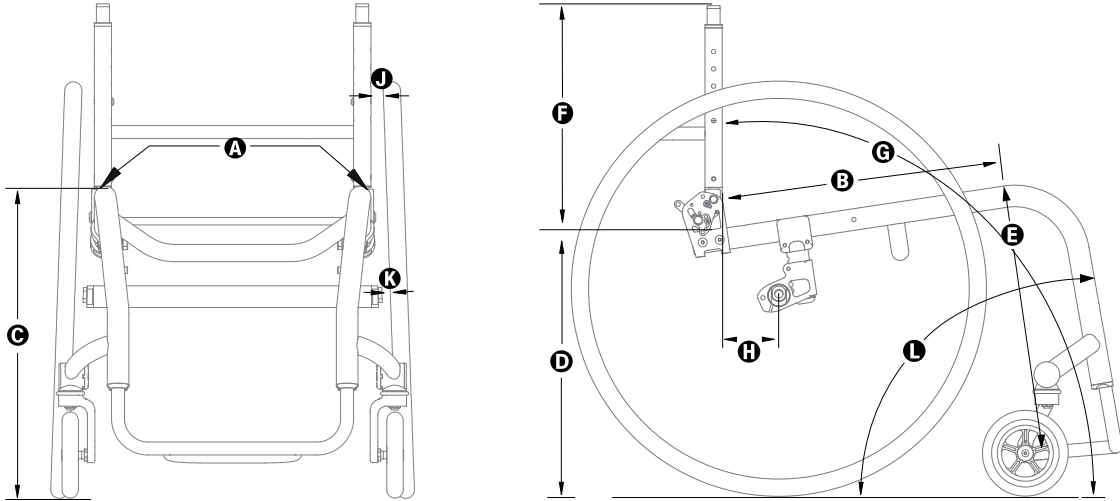

**REAR SEAT WIDTH A** Measure from outside of seat tube at back post to the outside of the opposite seat tube at back post.

- A2RSW4  10"  11"  12" (Weight Limit is restricted to 150 pounds on chairs with Rear Seat Width A and Seat Depth B from 10"x10" to 12"x12".)  13"  14"  15"  16"  17"  18"  19".....**STD**
- A2RSW2  20".....**\$450 E2201**

**FRONT SEAT WIDTH (SEAT TAPER) I** Measure from inside of front frame tube to inside of opposite front frame tube.

- A2FSW1  No Taper.....**STD**
- A2FSW3  1.5" Taper (4" Narrower than Rear Seat Width. Includes Tension Adjustable by Straps Seat Upholstery. Not available with 10" and 11" Seat Widths A.).....**\$250**
- A2FSW5  2.5" Taper (5" Narrower than Rear Seat Width. Includes Tension Adjustable by Straps Seat Upholstery. Not available with 10" to 14" Seat Widths A.).....**\$250**

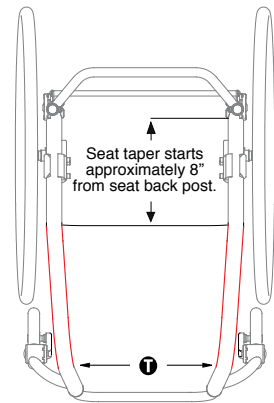

**SEAT DEPTH B** Measure from front of back post to the front edge of seat sling. Front edge of seat sling will be at the beginning of the bend at front of chair frame, unless Frog Legs® or 90° Front Angle is ordered, in which case front edge of seat sling begins approximately 1" behind the bend.

- A2SD1  10"  11"  12"  13"  14"  15"  16"  17"  18"  19".....**STD**
  - A2SD2  20".....**\$475 E2203**
  - A2SD3  Frame Depth Longer or Shorter Than Seat Depth (A Custom Frame Depth of 20" is \$450 if Seat Depth B of 20" is not also selected.).....**\$150**
- Custom Frame Depth: \_\_\_\_\_"

**FRONT SEAT HEIGHT C** Measure from floor to top of seat tube at beginning of bend. AERO Z adjusts up and down in 1/2" increments.

- A2FSH1  16"  16.5"  17"  17.5"  18"  18.5"  19"  19.5"  20"  20.5"  21".....**STD**

**REAR SEAT HEIGHT D** Measure from floor to top of seat tube at back post. AERO Z adjusts up and down in 1/2" increments.

**REAR SEAT HEIGHT RANGES**

Rear Wheel Size	AERO Z Rear Seat Heights D
20"	12.5" - 18.5"
22"	14.0" - 19"
24"	14.5" - 20"
25"	14.5" - 20"
26"	15.5" - 20"

- A2RSH1  12.5"  13"  13.5"  14"
- 14.5"  15"  15.5"  16"
- 16.5"  17"  17.5"  18"
- 18.5"  19"  19.5"  20".....**STD**

## FRAME MEASUREMENTS

**FRONT ANGLE ❶** Measure from frame front to floor.

- A2FA1  75°  80°  85° (85° Not available with 6" Front Wheels.) .....STD  
 A2FA8  90° (Not available with 5" or 6" Front Wheels.) .....\$150

**SEAT TO FOOTREST /FOOTRESTS** Measure from front edge of seat sling to top rear of footrest. **Measurement must be at least 2" shorter than Front Seat Height .**

### STANDARD FOOTRESTS

- 13.5"  14"  14.5"  15"  15.5"  16"  16.5"  17"  17.5"  18"  18.5"  19"
- A2FTR3  Angle Adjustable Footrest .....STD **K0040**  
 A2FTR1  Titanium Footrest w/Flat ABS Cover.....\$150  
 A2FTR2  Titanium Open Loop Footrest .....\$200  
 A2FTR12  Titanium Flip-Back Footrest (Not available w/ 10" or 11" Rear Seat Width ❶, Heavy Duty Edition, ABS Cover w/ 2" Sides, Front Roller.).....\$150

### HIGH MOUNT FOOTREST

- 7"-9"  9"-11"  11"-13 Set at: \_\_\_\_\_ (Use 1/2" increments)  
 A2FTR4  Angle Adjustable High Mount Footrest.....\$85 **K0040**
- A2FTR14  **ABS Cover w/2" Sides** (Not available with Flip-Back Footrest or chairs with 10" or 11" Rear Seat Width .).....\$95 **K0041**

**FOOTREST WIDTH ❶ or ❷** Select **either** a Standard Front End if no Seat Taper ❶ is selected on page 3 or a V-Front End if a Seat Taper ❶ is selected on page 3. ....STD

A2FE1 **STANDARD FRONT END ❶** Find your Rear Seat Width ❶ in the chart below and select one of the options to the right. Measure from inside of front frame tube to inside of opposite front frame tube. ....STD

REAR SEAT WIDTH ❶ (Outside Measurement)	FOOTREST WIDTH ❶		
	No Taper (2.5" Narrower than Rear Seat Width)	1.5" Taper (4" Narrower than Rear Seat Width)	3.5" Taper (6" Narrower than Rear Seat Width)
10"	<input type="checkbox"/> 7.5"		
11"	<input type="checkbox"/> 8.5"		
12"	<input type="checkbox"/> 9.5"	<input type="checkbox"/> 8"	
13"	<input type="checkbox"/> 10.5"	<input type="checkbox"/> 9"	
14"	<input type="checkbox"/> 11.5"	<input type="checkbox"/> 10"	
15"	<input type="checkbox"/> 12.5"	<input type="checkbox"/> 11"	<input type="checkbox"/> 9"
16"	<input type="checkbox"/> 13.5"	<input type="checkbox"/> 12"	<input type="checkbox"/> 10"
17"	<input type="checkbox"/> 14.5"	<input type="checkbox"/> 13"	<input type="checkbox"/> 11"
18"	<input type="checkbox"/> 15.5"	<input type="checkbox"/> 14"	<input type="checkbox"/> 12"
19"	<input type="checkbox"/> 16.5"	<input type="checkbox"/> 15"	<input type="checkbox"/> 13"
20"	<input type="checkbox"/> 17.5"	<input type="checkbox"/> 16"	<input type="checkbox"/> 14"

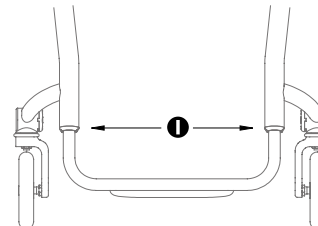

**OR**

A2FE2 **V-FRONT END ❷** Measure from inside of front frame tube to inside of opposite front frame tube 2-1/2" above footrest. (Titanium Flip-Back Footrest has 1" of adjustment up and down.).....\$150

**NO V-Front Taper**

**OR**

### FOOTREST WIDTH ❷

- 7"  7.5"  8"  8.5"  9"  9.5"  
 10"  10.5"  11"  11.5"  12"  12.5"  
 13"  13.5"  14"  14.5"  15"  15.5"  
 16"  16.5"  17"  17.5"  18"

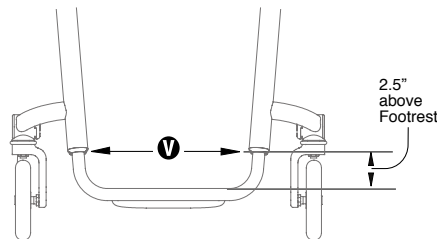

**SEAT BACK TYPE/PUSH HANDLES/SEAT BACK HEIGHT ❸** Measure from top of back post to top of seat tube at rear of frame.

### SEAT BACK TYPE

- A2SB1  Folding Aluminum Adjustable Height with 3" Deep Backrest Rigidizer Bar .....NCO  
 A2SB2  Folding Titanium Adjustable Height with 3" Deep Backrest Rigidizer Bar (Titanium back will match Frame Finish. Not available with Bolt-On Push Handles.).....\$175  
 A2SB11  Seat Back that Locks when Folded.....NCO

**FRAME MEASUREMENTS**

**TISHAFT™ BACK RELEASE BARS**

- A2SB3  Aluminum .....STD
- A2SB4  Titanium.....\$35
- A2SB5  Carbon Fiber.....\$65

**PUSH HANDLES**

- A2SB6  Integrated Push Handles.....NCO
- A2SB7  Integrated Fold-Down Push Handles (Requires Tension Adjustable by Straps Back Upholstery.).....\$100
- A2SB8  Bolt-On Push Handles (Requires 4" Deep Backrest Rigidizer Bar. Not available with Ti Back.).....\$175
- A2SB9  Bolt-On Height-Adjustable Push Handles (Requires 4" Deep Backrest Rigidizer Bar. Not available with Ti Back. Limited range with Depth Adjustable Back.).....\$295

**SEAT BACK HEIGHT ⑥**

Push Handles	Short	Medium	Tall	Set at: (Use 1/2" increments)
None	<input type="checkbox"/> 8.5"- 11.5"	<input type="checkbox"/> 12"- 16.5"	<input type="checkbox"/> 16.5"- 20.5"	Set at: _____
Integrated	<input type="checkbox"/> 10.5"- 12.5"	<input type="checkbox"/> 13.5"- 16.5"	<input type="checkbox"/> 17.5"- 20.5"	Set at: _____
Integrated Fold-Down	<input type="checkbox"/> 13"- 15.5"	<input type="checkbox"/> 14.5"- 19"	<input type="checkbox"/> 18.5"- 21"	Set at: _____

**AVAILABLE ON ALL BACKS**

- A2SB19  4" Deep Backrest Rigidizer Bar.....NCO
- A2SB16  Depth Adjustable Back/Frame (Not Available with 19" or 20" Seat Depths. Seat Depths ⑥ of 10"-18" allow 2" of rearward adjustment. Not available with Tension Adjustable by Straps Seat Upholstery, Carbon Fiber Side Guards or Desk Arms. Height Adjustable Push Handles have a limited range with Depth Adjustable Back.).....\$185
- A2SB13  Custom Height Backrest Rigidizer Bar (The Standard Rigidizer Bar height is 5" above the Seat Sling for a short, 6-1/4" for a medium and 10-1/4" for a tall. Custom Height Rigidizer Bar must be at least 4-1/2" above Seat Sling or 5-3/4" above Seat Sling when used with 11" - 14" Swing Away Tubular Armrests. Maximum Height is 3" less than Lowest Seat Back Height.)...\$150  
Set at: \_\_\_\_\_(Use 1/4" increments)

**SEAT BACK ANGLE ⑥** Measure angle from front of back post to floor. 90° will be perpendicular to the floor. To approximate the angle from the back post to the seat, subtract 2 degrees from measurement ⑥ for every 1/2" of dump.

- A2SBA1  80°  83°  86°  89°  92°  95°  98°  101°.....NCO

**CENTER OF GRAVITY ⑥** Measure from front of back post at the seat tube to the center of the rear axle. If no center of gravity is selected, chair will ship with the center of gravity in the rearward-most position.

- A2COG1  0"  .25"  .5"  .75"  1"  1.25"  1.5"  1.75"  2"  2.25"  2.5"  2.75"  3"  3.25"  3.5"  3.75"  4"  4.25"  4.5"  4.75"  5"  5.25"  5.5"  5.75"  6".....STD

**REAR WHEEL SPACING** Measure from outside of seat back post to inside of rear tire. 3/4" Rear Wheel Spacing not available with 0° or 2° Camber .

- A2RWS1  .75"  1"  1.25"  1.5"  1.75"  2".....STD

**CAMBER ③/CAMBER TUBES**

- A2CBR1  0°  2°  4°  6°  8°  12° .....STD
- A2CBR2  15°  18°.....\$75
- A2CBR3  Titanium Camber Tube (Not available with Power Adaptable Frame.).....\$50
- A2CBR6  Carbon Fiber Camber Tube (Not available with Power Adaptable Frame.).....\$175
- A2CBR5  Additional Aluminum Camber Tube  0°  2°  4°  6°  8°  12°  15°  18°.....\$100
- A2CBR4  Additional Titanium Camber Tube  0°  2°  4°  6°  8°  12°  15°  18° .....\$100
- A2CBR7  Additional Carbon Fiber Camber Tube  0°  2°  4°  6°  8°  12°  15°  18° .....\$225
- A2CBR9  Additional Spacers to Increase Rear Wheel Spacing.....NCO

**CHAIR OPTIONS**

**FRONT WHEELS**

- A2FW1  3"x.75" Micro-Caster (Not available with Slipstream Fork.).....STD
- A2FW2  3"x.75" Light-Up Micro-Caster (Not available with Slipstream Fork.).....\$70
- A2FW23  3"x1.5" Billet Aluminum Micro Caster w/Soft Roll Tire (Available with Slipstream Fork only.).....\$155
- A2FW14  4"x.75" Plastic Wheel w/Poly Tire (Not available with Slipstream Fork.).....NCO
- A2FW3  4"x.75" Light-Up Micro-Caster (Not available with Slipstream Fork.).....\$70
- A2FW19  4"x.75" Performance 5 Spoke Billet Aluminum Wheel w/Poly Tire  Silver Hub **OR**  Black Hub.....\$125
- A2FW20  4"x1" Performance 5 Spoke 2-Piece Billet Aluminum Wheel w/Soft Roll Tire  Silver Hub **OR**  Black Hub.....\$165
- A2FW15  4"x1.5" Plastic Wheel w/Poly Tire.....\$80



## CHAIR OPTIONS

### FRONT WHEELS

A2FW6	<input type="checkbox"/> 5"x1"	Plastic Wheel w/Poly Tire (Not available with 90° Front Angle <b>Ⓛ</b> or with Slipstream Fork.).....	<b>NCO</b>
A2FW21	<input type="checkbox"/> 5"x1"	Performance 5 Spoke Billet Aluminum Wheel w/Poly Tire <input type="checkbox"/> Silver Hub <b>OR</b> <input type="checkbox"/> Black Hub (Not available with 90° Front Angle <b>Ⓛ</b> ).....	<b>\$145</b>
A2FW22	<input type="checkbox"/> 5"x1"	Performance 5 Spoke 2-Piece Billet Aluminum Wheel w/Soft Roll Tire <input type="checkbox"/> Silver Hub <b>OR</b> <input type="checkbox"/> Black Hub (Not available with 90° Front Angle <b>Ⓛ</b> ).....	<b>\$185</b>
A2FW18	<input type="checkbox"/> 5"x1.5"	Plastic Wheel w/Poly Tire (Not available with 90° Front Angle <b>Ⓛ</b> ).....	<b>\$80</b>
A2FW9	<input type="checkbox"/> 6"x1"	Plastic Wheel w/Poly Tire (Not available with 85° or 90° Front Angle <b>Ⓛ</b> or with Slipstream Fork.).....	<b>NCO</b>
A2FW11	<input type="checkbox"/> 6"x1"	Billet Aluminum Wheel w/Poly Tire <input type="checkbox"/> Silver Hub <b>OR</b> <input type="checkbox"/> Black Hub (Not available with 85° or 90° Front Angle <b>Ⓛ</b> or with Slipstream Fork.).....	<b>\$165</b>
A2FW10	<input type="checkbox"/> 6"x1.25"	Plastic Wheel w/Pneumatic Tire (Not available with 85° or 90° Front Angle <b>Ⓛ</b> or with Slipstream Fork.).....	<b>\$65</b>
A2FW12	<input type="checkbox"/> 6"x1.25"	Billet Aluminum Wheel w/Pneumatic Tire <input type="checkbox"/> Silver Hub <b>OR</b> <input type="checkbox"/> Black Hub (Not available with 85° or 90° Front Angle <b>Ⓛ</b> or with Slipstream Fork.).....	<b>\$165</b>
A2FW13	<input type="checkbox"/> 6"x1.25"	2-Piece Billet Aluminum Wheel w/Soft Roll Tire (Not available with 85° or 90° Front Angle <b>Ⓛ</b> or with Slipstream Fork.).....	<b>\$195</b>
A2FW0	<input type="checkbox"/>	Omit Front Wheels (Must Choose Wheel Size Above).....	<b>-\$20</b>

### FRONT FORKS

A2FK1	<input type="checkbox"/>	TiLite Standard Fork.....	<b>STD</b>
A2FK2	<input type="checkbox"/>	TiLite Slipstream Single-Sided Fork.....	<b>\$150</b>
A2FRG1	<input type="checkbox"/>	Frog Legs® Suspension Forks (Available in Black anodize only.).....	<b>\$395 E1015</b>
A2TS1	<input type="checkbox"/>	Titanium Fork Stems (Not available with Frog Legs®).....	<b>\$50</b>

### REAR WHEELS See Rear Seat Height Ranges chart on Page 3 for Rear Seat Height **Ⓛ** limitations.

A2RW14	TiLite SHADOW™ (Not available with Titanium Quick Release Axles or Heavy Duty Edition.).....		<b>STD</b>
	<input type="checkbox"/>	20"(451)	
	<input type="checkbox"/>	22"(501)	
	<input type="checkbox"/>	24"(540)	
	<input type="checkbox"/>	25"(559) (Requires 15" minimum Seat Depth <b>Ⓛ</b> .)	
	<input type="checkbox"/>	26"(590) (Requires 15" minimum Seat Depth <b>Ⓛ</b> .)	
A2RW12	TiLite DASH (Not available with Titanium Quick Release Axles.).....		<b>\$100</b>
	<input type="checkbox"/>	20"(451)	
A2RW5	TiLite High Flange Hub (Not available with Titanium Quick Release Axles.).....		<b>\$250</b>
	<input type="checkbox"/>	24"(540)	
	<input type="checkbox"/>	25"(559) (Requires 15" minimum Seat Depth <b>Ⓛ</b> .)	
	<input type="checkbox"/>	26"(590) (Requires 15" minimum Seat Depth <b>Ⓛ</b> .)	
A2RW13	Golz TWIN-STAR Exchange (Not available with Titanium Quick Release Axles.).....		<b>\$895</b>
	<input type="checkbox"/>	24"(540)	
	<input type="checkbox"/>	25"(559) (Requires 15" minimum Seat Depth <b>Ⓛ</b> .)	
A2RW7	Spinergy SPOX <input type="checkbox"/> Black <input type="checkbox"/> Red <input type="checkbox"/> Yellow <input type="checkbox"/> Blue <input type="checkbox"/> White .....		<b>\$695</b>
	<input type="checkbox"/>	22"(501) - Std. Hub	
	<input type="checkbox"/>	24"(540) - Std. Hub	
	<input type="checkbox"/>	25"(559) - Std. Hub (Requires 15" minimum Seat Depth <b>Ⓛ</b> .)	
	<input type="checkbox"/>	26"(590) - Sport Hub (Requires 15" minimum Seat Depth <b>Ⓛ</b> . Not available with Titanium Quick Release or Quad Release Axles.)	
A2RW8	Spinergy LX <input type="checkbox"/> Black <input type="checkbox"/> Red <input type="checkbox"/> Yellow <input type="checkbox"/> Blue <input type="checkbox"/> White <input type="checkbox"/> Go Green <input type="checkbox"/> Bright Orange <input type="checkbox"/> Flamingo Pink (Please allow an additional 2-3 weeks delivery on Go Green, Bright Orange and Flamingo Pink.) ...		<b>\$895</b>
	<input type="checkbox"/>	22"(501) - Std. Hub	
	<input type="checkbox"/>	24"(540) - Std. Hub	
	<input type="checkbox"/>	25"(559) - Std. Hub (Requires 15" minimum Seat Depth <b>Ⓛ</b> .)	
	<input type="checkbox"/>	26"(590) - Sport Hub (Requires 15" minimum Seat Depth <b>Ⓛ</b> . Not available with Titanium Quick Release or Quad Release Axles.)	
A2RW11	Skyway Mags <input type="checkbox"/> 22" <input type="checkbox"/> 24" (Not available with Short Tabs, Titanium Quick Release Axles, Quad Release Axles or Spoke Guards or Heavy Duty Edition.) .....		<b>\$50</b>
A2RW0	<input type="checkbox"/>	Omit Rear Wheels (Must choose Wheel Size and Tire Type below.).....	<b>-\$50</b>

### AXLES

A2AXL1	<input type="checkbox"/>	Stainless Quick Release.....	<b>STD</b>
A2AXL2	<input type="checkbox"/>	Titanium Quick Release (Not available with TiLite High Flange Hub, TWIN-STAR Exchange, DASH, SHADOW, Skyway Mags, 26"(590) Spinergy SPOX or LX Rear Wheels or Power Adaptable Frame.).....	<b>\$195</b>
A2AXL3	<input type="checkbox"/>	Quad Release (Not available with Skyway Mags or 26" (590) Spinergy Spox or LX RearWheels.).....	<b>\$95</b>

### PNEUMATIC REAR TIRES

A2RTR1	<input type="checkbox"/>	Treaded (Not available with 25"(559) Rear Wheels.) .....	<b>STD</b>
	<input type="checkbox"/>	Airless Inserts .....	<b>\$80 E2213</b>
A2RTR3	<input type="checkbox"/>	25" Primo Treaded (Standard with 25"(559) Rear Wheels.).....	<b>STD</b>
A2RTR4	<input type="checkbox"/>	Primo .....	<b>NCO</b>
A2RTR16	<input type="checkbox"/>	20" Kenda® Grey High Pressure (110psi) .....	<b>\$95</b>
A2RTR5	<input type="checkbox"/>	24", 25" and 26" Kenda® High Pressure (110psi) <input type="checkbox"/> Grey <input type="checkbox"/> Red <input type="checkbox"/> Blue.....	<b>\$95</b>

## CHAIR OPTIONS

### PNEUMATIC REAR TIRES

A2RTR6 <input type="checkbox"/> 24" Grey Knobby (Requires TiLite Wheel with High Flange Hub.).....	\$95
A2RTR7 <input type="checkbox"/> 26" Black Knobby (Requires TiLite Wheel with High Flange Hub or Spinergy SPOX or Spinergy LX Rear Wheels.).....	\$95
A2RTR8 <input type="checkbox"/> 24", 25" and 26" Schwalbe® Marathon Plus Evolution.....	\$125
A2RTR9 <input type="checkbox"/> 24" and 25" Schwalbe® SpeedRun.....	\$125

### SOLID REAR TIRES

A2RTR10 <input type="checkbox"/> 20" (451) Street Tread.....	\$65
A2RTR11 <input type="checkbox"/> 22" (501) Pyramid.....	\$75
A2RTR13 <input type="checkbox"/> 24"(540) and 25"(559) Herringbone Tread.....	\$95
A2RTR15 <input type="checkbox"/> 24"(540) and 25"(559) Treaded.....	\$95

### HANDRIMS

**Handrims by OUT-FRONT®** (If the Rugged Edition is selected on Page 2, please select two sets of handrims and indicate SPOX or HF next to each of your selections to indicate that they should be attached to either the Spinergy SPOX or TiLite High Flange Rear Wheels.)

A2RIM1 <input type="checkbox"/> Aluminum – Silver Anodized.....	STD
Titanium (Not available with Skyway Mags, 20" or 22" Rear Wheels, or 24" Knobby tires.)	
A2RIM12 <input type="checkbox"/> Satin Finish.....	\$400
A2RIM13 <input type="checkbox"/> Polished Finish.....	\$550
The Natural-Fit® (Original, Larger Profile) (Not available with 22" Skyway Mags.)	
A2RIM14 <input type="checkbox"/> Standard Grip (Not available with Short Tabs.).....	\$295
A2RIM15 <input type="checkbox"/> Super Grip (Not available with Short Tabs.).....	\$340
A2RIM16 <input type="checkbox"/> Without Thumb Grip.....	\$270
The Natural-Fit® LT (Reduced Weight, Smaller Profile) (Not available with 22" Skyway Mags.)	
A2RIM17 <input type="checkbox"/> Standard Grip (Not available with Short Tabs.).....	\$325
A2RIM18 <input type="checkbox"/> Super Grip (Not available with Short Tabs.).....	\$370
A2RIM19 <input type="checkbox"/> Without Thumb Grip.....	\$300
A2RIM10 <input type="checkbox"/> The Surge (All-In-One Oval with Gription™ Strip, Larger Profile) (Not available with 22" Skyway Mags.).....	\$315
A2RIM11 <input type="checkbox"/> The Surge LT (All-In-One Oval with Gription™ Strip, Smaller Profile) (Not available with 22" Skyway Mags.).....	\$340
A2RIM20 <input type="checkbox"/> Q-Grip (Exclusive High-Friction, Anti-Slip Coating) (Not available with 22" or 26" Rear Wheels or Skyway Mags.).....	\$295

#### Additional Handrims

A2RIM9 <input type="checkbox"/> Spinergy FlexRim (Available only on 24" and 25" Spinergy LX Rear Wheels. Please allow an additional 2-3 weeks delivery.).....	\$525
A2RIM5 <input type="checkbox"/> Plastic Coated – Black.....	\$95
A2RIM6 <input type="checkbox"/> Projections - 8 Vertical Projections (Not available with 20", 22" or 26" Rear Wheels or Skyway Mags.).....	\$240
A2RIM0 <input type="checkbox"/> Omit Handrims.....	\$15

#### Tab Length

A2RIM7 <input type="checkbox"/> Long Tabs.....	STD
A2RIM8 <input type="checkbox"/> Short Tabs (Not available with Skyway Mags or The Natural-Fit® Handrims with Thumb Grip.).....	\$15

### WHEEL LOCKS

A2WLK7 <input type="checkbox"/> Compact Composite Push to Lock (Available with .75" to 1.5" Rear Wheel Spacing <b>1</b> only).....	NCO
A2WLK8 <input type="checkbox"/> Compact Composite Pull to Lock (Available with .75" to 1.5" Rear Wheel Spacing <b>1</b> only).....	NCO
A2WLK10 <input type="checkbox"/> Extension Handles for Compact Composite Push/Pull to Lock.....	\$75 E0961
A2WLK9 <input type="checkbox"/> Composite Scissor Lock.....	\$125
A2WLK5 <input type="checkbox"/> Black Aluminum Scissor Lock.....	\$135
A2WLK3 <input type="checkbox"/> Uni-Lock Set At: <input type="checkbox"/> Push <b>OR</b> <input type="checkbox"/> Pull.....	\$135
A2WLK4 <input type="checkbox"/> Extension Handles for Uni-Lock.....	\$75 E0961

### UPHOLSTERY COLORS

A2UPC1 <input type="checkbox"/> Black.....	STD
A2UPC3 Ultrasuede Backrest Stripe (See photo on page 1.) <input type="checkbox"/> Black <input type="checkbox"/> Sapphire <input type="checkbox"/> Red Pepper <input type="checkbox"/> Burnt Orange <input type="checkbox"/> Sub-Lime <input type="checkbox"/> Ultraviolet <input type="checkbox"/> Espresso.....	\$70

### BACK UPHOLSTERY

A2BUP2 <input type="checkbox"/> Velcro Adjustable (Not available with Fold-Down Push Handles.).....	STD
A2BUP3 <input type="checkbox"/> Tension Adjustable by Straps (Required with Fold-Down Push Handles.).....	\$175
A2BUP0 <input type="checkbox"/> Omit Back Upholstery.....	NCO
A2BUP4 <input type="checkbox"/> Ride Designs® Corbac™ Adjustable Contour Back Support (Black only. Not available with Fold-Down Push Handles. See Chart on page 8.).....	\$455 E2611

### CORBAC™ SEAT WIDTH/BACK HEIGHT AVAILABILITY CHART

Rear Seat Width <b>A</b>	Seat Back Height <b>B</b>
14"	13" - 15"
15"	13" - 16"
16"	14" - 16"
17"	14" - 16"
18"	14" - 16"

## CHAIR OPTIONS

### SEAT UPHOLSTERY

- A2SUP1  Tension Adjustable Bolt On (Not available with Tapered Seat **Ⓢ**. Black only.).....**STD**  
A2SUP7  iSleeve™ Under Seat Smartphone Holder (Not available with 10" to 13" Rear Seat Width **Ⓐ** or Seat Depth **Ⓢ**)....**\$50**
- A2SUP2  Tension Adjustable by Straps (Standard Front Seat Width (Seat Taper) **Ⓢ** of 1.5" and 2.5". Black only.  
 Not available with Depth Adjustable Back.).....**\$150**
- A2SUP3  G10 Solid Seat (Not available with 10" or 11" Rear Seat Width **Ⓐ**)......**\$225 E2618**
- A2SUP0  Omit Seat Upholstery.....**NC0**

### SEAT CUSHIONS

- A2CSH1  Foam Cushion  2"  3"  4".....**\$95**
- A2CSH2  StimuLITE® Sport (2" Black 13"x15" to 20"x20") (Please allow an additional 2-3 weeks delivery. Black upholstery only.).....**\$495 E2603**
- A2CSH3  Corbee® (2" Black 10"x10" to 16"x16") (Please allow an additional 2-3 weeks delivery. Black upholstery only.).....**\$495 E2603**
- A2CSH4  ROHO® Low Profile® Quadtro Select® (Please allow an additional 2-3 weeks delivery. Black upholstery only.).....**\$525 E2624**
- A2CSH5  ROHO® Custom (Please allow an additional 2-3 weeks delivery. Black upholstery only.).....**\$625 E2609**
- A2CSH6  VARILITE® Evolution™ (Black only, see chart below.).....**\$495 E2622**
- A2CSH7  VARILITE® Zoid™ (Black only, see chart below.).....**\$495 E2622**

### VARILITE® SEAT CUSHION AVAILABILITY CHART

Seat Depth **Ⓢ**

Seat Width	VARILITE® Evolution™	VARILITE® Zoid™
12"	14"	8", 12", 14"
13"	NONE	NONE
14"	14", 16", 18", 20"	14", 16", 18"
15"	15", 17"	15", 17"
16"	14", 16", 18", 20"	16", 18", 20"
17"	17"	17"
18"	16", 18", 20"	16", 18", 20"
19"	NONE	NONE
20"	16", 18", 20"	16", 18", 20"

### SIDE GUARDS

- A2SDG1  Cloth (Not available with Ride Designs® Corbac™ back support.).....**\$65**
- Aluminum**
- A2SDG2  Rigid Removable  Small **OR**  Std.....**\$175**
- A2SDG3  Quad Removable w/Hole  Small **OR**  Std.....**\$185**
- A2SDG4  Fold Down Rigid  Small **OR**  Std.....**\$295**
- A2SDG6  Fendered Adjustable (Available with 24" and 25" Rear Wheels. Requires Rear Seat Height **Ⓢ** of 14.5" to 18.5").....**\$295**
- Carbon Fiber** (Not available with Depth Adjustable Back/Frame.)
- A2SDG7  Rigid Removable  Small **OR**  Std.....**\$270**
- A2SDG8  Quad Removable w/Hole  Small **OR**  Std.....**\$280**
- A2SDG9  Fold Down Rigid  Small **OR**  Std.....**\$400**
- A2SDG12  Fendered Removable.....**\$395**
- Available on Aluminum and Carbon Fiber Non-Fendered Side Guards**
- A2SDG13  Side Guards Custom Cut to Profile of Rear Wheels (Not available with Cloth.).....**\$275**

### ARMRESTS

- A2ARM1  Swing Away Tubular  9" to 12" **OR**  11" to 14" (Not available with Depth Adjustable Back/Frame.).....**\$195 E0973**
- A2ARM4  Swing Away - Flip Back Tubular  6" to 9" **OR**  9" to 12".....**\$275 E0973**
- A2ARM2  Removable Height Adjustable Desk Arm with Rigid Side Guard (Not available with Depth Adjustable Back/Frame.  
 Requires 14" minimum Seat Depth **Ⓢ**.) .....**\$295 E0973**  
 9" to 12" **OR**  12" to 15"  
 Standard Length Pad (10") **OR**  Full Length Pad (14")
- A2ARM3  Removable Height Adjustable Desk Arm with Rigid Side Guard and Transfer Loop .....**\$340 E0973**  
 (Not available with Depth Adjustable Back/Frame. Requires 15" minimum Seat Depth **Ⓢ**.)  
 9" to 12" **OR**  12" to 15"  
 Standard Length Pad (10") **OR**  Full Length Pad (14")
- Available on all Armrests**
- A2ARM5  Covered in Black Ultrasuede.....**\$75**

### SEAT BELTS

- A2BLT1  Velcro Adjustable, Black Nylon Webbing.....**\$45 E0978**
- A2BLT2  Bodypoint® 2" Push-Button Buckle (Auto-Style.).....**\$85 E0978**
- A2BLT4  Bodypoint® 1" Wide Push-Button Buckle Padded (Auto-Style.) (Not available with 19" or 20" Rear Seat Widths **Ⓐ**).).....**\$155 E0978**
- A2BLT5  Bodypoint® 1.5" Wide Push-Button Buckle Padded (Auto-Style.) (Not available with 19" or 20" Rear Seat Widths **Ⓐ**).).....**\$155 E0978**
- A2BLT6  Bodypoint® 1.5" Wide Rehab Latch Buckle Padded (Airline-Style.) (Not available with 19" or 20" Rear Seat Widths **Ⓐ**).).....**\$155 E0978**
- A2BLT7  Bodypoint® 1.5" Wide Plastic Side Release Padded (Not available with 19" or 20" Rear Seat Widths **Ⓐ**).).....**\$120 E0978**



## CHAIR OPTIONS

### CALF STRAP

- A2CLF1  Buckle Adjustable, Black Nylon Webbing.....\$25 K0038
- A2CLF2  Velcro Adjustable .....\$35 K0038
  - Xtra Small (Recommended for 10"- 13" Seat Widths)
  - Small (Recommended for 12"- 15" Seat Widths)
  - Medium (Recommended for 14"- 18" Seat Widths)
  - Large (Recommended for 17"- 19" Seat Widths)
  - Xtra Large (Recommended for 18"- 20" Seat Widths)
- A2CLF3  Bodypoint Padded Velcro Adjustable .....\$75 K0038
  - Small (Recommended for 10"- 11" Seat Widths)
  - Medium (Recommended for 12"- 15" Seat Widths)
  - Large (Recommended for 16"- 20" Seat Widths)

### BACK PACK

- A2BCK1  Small - Black Nylon .....\$50
- A2BCK2  Large - Black Nylon.....\$65

### SEAT POUCH

- A2PCH1  Small - Black Nylon.....\$40
- A2PCH2  Large - Black Nylon.....\$45



### SPOKE GUARDS

- A2GRD1  Clear with TiMotion Logo (Not available with Skyway Mags or 20" Rear Wheels.) .....\$115 K0065

### ANTI-TIPS

- A2TIP1  Black Aluminum.....\$135 E0971
- A2TIP2  User Friendly Flip-up.....\$245 E0971

### ACCESSORIES

- A2UEST1  Upper Extremity Support Tray  12" to 14" OR  13" to 15" Seat Widths  (Requires Armrests.).....\$250 E0950
- A2LUG1  Luggage Carriers.....\$125
- A2MPCT2 Neoprene Impact Guards with Ultrasuede Stripe  Black  Sapphire  Red Pepper  Burnt Orange
  - Sub-Lime  Ultraviolet  Espresso.....\$90
- A2CAT1  Catch-All.....\$75
- A2CH1  Crutch Holder.....\$150 E2207
- A2TS1 TiLite T-Shirt  Small  Medium  Large  X-Large  XX-Large.....\$25
- A2TIP5  Front Roller (Requires that Seat to Footrest Measurement  be at least 3" shorter than Front Seat Height . Not available w/ Titanium Flip-Back Footrest.).....\$95
- A2HS1  TiLite 9 Piece SAE Round Handle Folding Hex Key Set.....\$25
- A2AFP1 4" Logo Patch  Army  Navy  Air Force  Marines .....\$50
- A2AFP2 Name Tape Patch  Army  Navy  Air Force  Marines .....\$50
- A2AFP3  Combat Wounded Purple Heart Patch.....\$50

## DESIGNS UNLIMITED



TiLite's AERO Z Series 2 offers more than 15 million different frame combinations! But sometimes even that's not enough. If you would like to customize your TiLite, check out the Designs Unlimited Studio at [tilite.com](http://tilite.com). There you will find drawings and pricing for hundreds of creative solutions to customers' customization requests. We call these "D.U.'s." If you don't find the D.U. you're looking for, contact the TiLite Customer Service Team at 800.545.2266 or [customerservice@tilite.com](mailto:customerservice@tilite.com) and we'll design a D.U. just for you. Designs Unlimited customization may add an additional 2 to 3 weeks to the ship time of your chair.

## GENERAL

TiLite manufactures a wide variety of wheelchairs to meet the varied needs of wheelchair users. The final selection of a particular model, its options and accessories, and its measurements rests solely with the wheelchair user and advising healthcare professional. TiLite wheelchairs must be fitted by a qualified healthcare professional. HCPCS Codes are for reference purposes only. Actual coding and coverage varies by payer. Proper HCPCS coding is not a guarantee of payment. Please verify the appropriate payer's coverage policy.

Get the latest order forms at [tilite.com](http://tilite.com) Prices, standard features, options and accessories are subject to change without notice. All rights reserved. Trademarks are identified by symbols™ and ®. TiLite, the TiLite logo, Ti, the Ti logo, The Titanium Experts, TiShaft and The Ultimate Ride are registered trademarks of TiSport, LLC. Adobe®, Acrobat®, Acrobat Professional® and Reader® are registered trademarks of Adobe Systems Inc. Bodypoint® is a registered trademark of Bodypoint Inc. Frog Legs® is a registered trademark of Frog Legs, Inc. Kenda® is a registered trademark of Kenda Rubber Industrial Co Ltd. Ride Designs® and Corbac® are registered trademarks of Aspen Seating, LLC. ROHO®, Low Profile® and Quadro Select® are registered trademarks of ROHO Inc. Schwalbe® is a registered trademark of Ralf Bohle GmbH. Supracor®, Stimulite® and Corbee® are registered trademarks of Supracor, Inc. The Natural-Fit® is a registered trademark of Three Rivers Holdings, LLC. Varilite® is a registered trademark of Cascade Designs, Inc.

## NOTES

If you are using Adobe Acrobat, this order form may be converted into a quote request or into an order by clicking one of the buttons below (this feature is available exclusively to TiLite dealers and distributors). A TiLite Quote or a TiLite Order Confirmation will be sent to you within 24 hours.

**QUOTE THIS CHAIR**

**ORDER THIS CHAIR**