

ICS Onboard Configuration

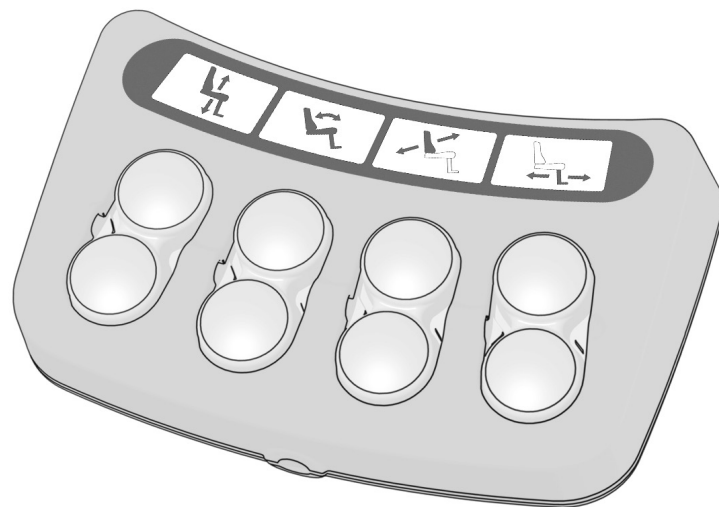

How to contact Permobil

Permobil Inc.

300 Duke Drive
Lebanon, TN 37090

PH: 800.736.0925
FAX: 800.231.3256
info@permobil.com

Head Office of the Permobil group

Permobil AB

Box 120
861 23 Timrå
Sverige

Tlf. +46 60 59 59 00
Fax +46 60 57 52 50
E-mail: info@permobil.se

Contents

Chapter 1 – Operation	6
Introduction	6
General	6
System hardware	6
Controls and feedback	7
General	7
Switchbox layout	7
Icons	8
Switchbox LEDs	9
Switchbox LED colors and their meanings	10
Basic seat operation through switchbox	10
Controlling seat functions	10
Advanced seat operation through switchbox	12
Seat function memory overview	12
Seat function memory step-by-step	13
Basic seat operation through R-net control panel	15
Advanced seat operation through R-net control panel	16
Recalling a seat position from memory	16
Storing a seat position in memory	17
Standing function (only applies to VS Seat)	18
Standing operation through switchbox	18
Standing operation through Pilot+ joystick	20
Chapter 2 – Programming	21
General	21
ICS Switchbox programming	21
R-net control panel programming	21
PC programming	21
Configuring using the ICS Switchbox	22
Global settings	22
Selecting a user weight range	22
Selecting the LED indication level	24
Switchbox label sheet	25
Choosing a switchbox layout	26
Other general settings	28
Corpus II Specific attributes	30
Setting legrest angle for speed reduction	30
45° tilt calibration C400/C500 Corpus	32
Corpus 3G - Specific attributes	33
IRM - Independent Repositioning Mode	33
Setting of Corpus 3G Seat Depth	37
Corpus 3G on M300/M400 och C350	38
Corpus VS /Corpus APE - Specific Attributes	40
Setting up a Standing Sequence and Ground Clearance	40
VS Specific attributes	45
Choosing a standing sequence	45

Setting legrest type	51
Setting optional tilt	52
K450 Specific attributes	53
Enabling transport position mode	53
Setting optional tilt	54
Setting seat width and armrest type	55
Performing automatic actuator calibration	57
Performing manual actuator calibration	59
Transportation (WC19) mode hook position	60
Configuring ICS through R-net control panel	61
Enabling the ICS menu in OBP	61
Changing the seat function order in Seating Mode	62
Limiting the seat's permitted movements	63
Adjusting the seat position for speed reduction	63
Adding or removing seat functions	64
Configuring functions for Alternative Switchbox	65
Configuring ICS through R-net PC programmer	66
Chapter 3 – Diagnostics & troubleshooting	67
Diagnostic LED indications	67
Overview of the “user level” indications:	67
“Diagnostic level” indications:	67
Seat elevator SoftPot error mode	68
Chapter 4 – Servicing	69
ICS bus connections	69
APE-actuator Recalibration Mode.....	70
Switchbox replacement	71
Actuator replacement	71
General module replacement	71
Smart actuator calibration	72
Actuator calibration with SoftPot	76
Emergency manual operation mode (take me down)	78
Appendix 1 - Definition of seat function types	80

Chapter 1 - Operation

Introduction

General

The Intelligent Control System (ICS) controls the Powered Seat Functions and provides Drive Inhibit information to the Driving System.

System Hardware

The Intelligent Control System consists of the following components. Please note, not all components are used in all configurations.

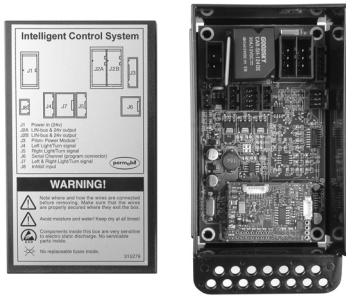

ICS Master Module

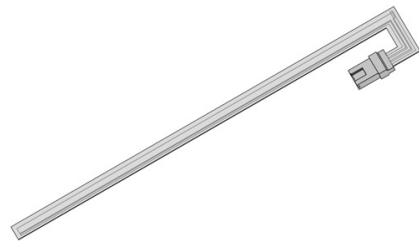

SoftPot Position Sensor



Switchbox



Connector Block

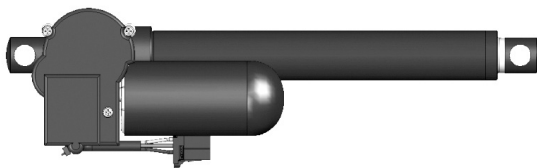

Smart Actuator



Standard Actuator



General Module



ICS Bus Cable

Controls and Feedback

Controls and Feedback

There are two styles of ICS Switchbox, Pushbutton or Toggle, each offers the same functionality

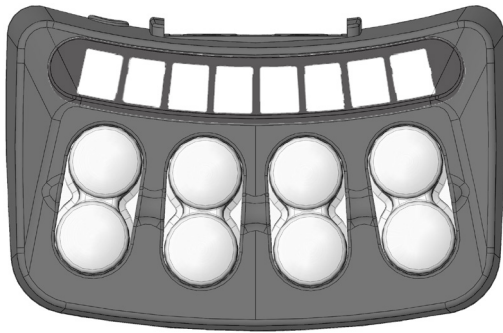

Pushbutton Switchbox

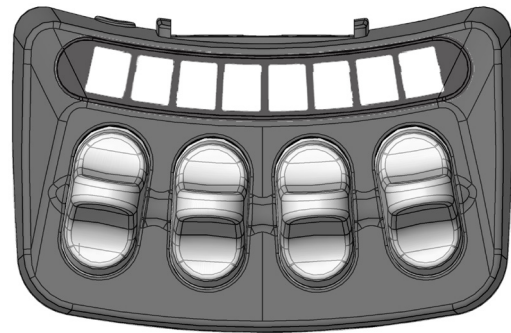

Toggle Switchbox

Switchbox Layout

The functionality of the buttons in the switchbox is programmable. Different switchbox layouts are available for each seating system. Samples of these layouts are below, more information on selecting a layout is found in the Choosing a Switchbox Layout section of the Programming chapter.

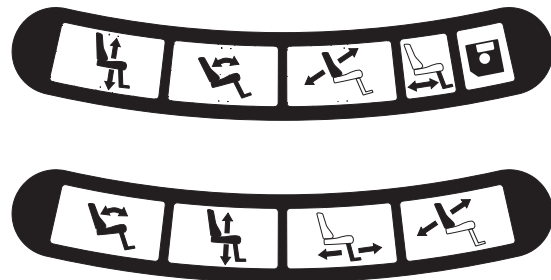
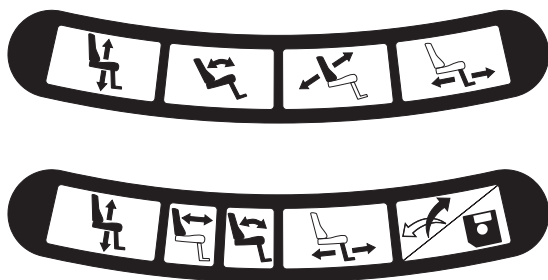

Icons

The ICS uses Icons to represent Seat Functions and System Features. Each Icon used in the ICS is explained below. Please note that not all icons are used in every seat configuration.



Seat Elevator



Power Recline



Power Anterior Tilt



*Standing Sequence
'A'*



*Power Tilt
(Posterior Only)*



*Standing Sequence
'B'*



Elevating Legrest



"Swap"



Memory Mode

Switchbox LEDs

In addition to the button symbols, the switchbox provides feedback through its built-in LEDs. Each button and function has its own LED. The information presented by the LEDs is related to available seat function, active seat function inhibit, active drive speed limit, active drive inhibit and system errors.

There are three light states that the LED above the switch can have, Off, Solid or Flashing. A solid LED communicates drive-related information. A flashing LED communicates actuator-related information.

There are three colors that the LED above the switch can have, Green, Yellow or Red. A green LED communicates “ok”, “ready” or “go” (i.e. full speed). A yellow LED communicates some kind of restriction. (i.e. half speed). A red LED communicates some kind of stop or error. (i.e. drive inhibit).

The states and the colors of the LEDs give information about the system and the actual situation. Below are some examples:



Seat Function Icon is “OFF”

This signifies that the seat function is not currently active. The selection of the Left/Right seat functions is toggled with the Swap Switch.



Seat Function Icon is “GREEN” (solid)

This signifies that the seat function is responsive, activating the switch below the icon will move the seat function. This also shows that this seat function is not limiting the Drive Speed of the chair.



Seat Function Icon is “YELLOW” (solid)

This signifies that the seat function is responsive, activating the switch below the icon will move the seat function. But, the chair Drive Speed is Limited due to the position of this function.



Seat Function Icon is “RED” (solid)

This signifies that the seat function is responsive, activating the switch below the icon will move the seat function. But, the chair Drive is Inhibited due to the position of this actuator.



Seat Function Icon is “FLASHING GREEN”

This indication signifies a special or extended feature. i.e. Memory Mode.



Seat Function Icon is “FLASHING YELLOW”







The Seat Function is Inhibited in one direction, due to a safety limit. This signifies that the seat function is responsive, however, activating the switch below the icon will only move the seat function in the “safe” direction.



Seat Function Icon is “FLASHING RED”

This signifies that there has been an error detected with the Seat Function. Since there are several error conditions, activating the switch below the icon may not operate the seat function. It is recommended to note the seat position and what occurred just before the RED Flash began, as this information can aid your service representative.

Switchbox LED Colors and their meanings

LED Off	Solid Colors Communicate Drive Related Information.	Flashing Colors Communicate Actuator Related Information.
 <p>Function not available right now.</p>	 <p>All OK Drive Full Speed.</p>	 <p>Special Mode (Memory / Configuration)</p>
	 <p>Seat OK Drive Speed Limited.</p>	 <p>Safety Limit Reached Will only move one direction.</p>
	 <p>Seat OK Drive Inhibited.</p>	 <p>Actuator Problem Overcurrent, Comm, etc.</p>

Basic Seat Operation through Switchbox

Controlling Seat Functions

The Seating System Power Functions can be controlled via the ICS Switchbox. The ICS Switchbox has eight switches (pushbuttons or toggles) and eight LEDs as seen below.

Depending on the Switchbox Layout that has been selected and the mode that the Switchbox is currently in, the functionality of each switch can be different.

When using the ICS Switchbox, it is important to note the Position, Color and “Light Type” (Solid/Flashing) of the LEDs that illuminate the Icons on the Switchbox.

These different characteristics communicate the current switchbox mode and which seat function a particular switch will control.



Switchbox Examples

The indications on the switchbox above communicate:

- Switches 2 & 6 will operate the Seat Elevator
- Switches 1 & 5 will not operate a Seat Function
- Switches 3 & 7 will operate the Legrest (LEDs 1 & 2 are off.)
- Switches 4 & 8 will operate the Backrest
- The Seat Elevator position is limiting the Chair's Drive Speed. (LEDs 3 & 4 are solid yellow.)

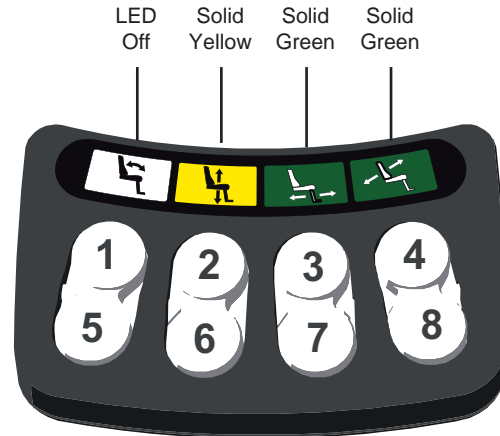

The indications on the switchbox above communicate:

- Switches 1 & 5 will operate Standing Sequence Switch 4 will "swap" switches 2/6 & 3/7
- Switches 2 & 6 will operate the Backrest (to enable operation of elevator and tilt)
- Switches 3 & 7 will operate the Legrest Switch 8 will enter "memory mode"
- The Standing position is preventing the Chair from Driving (LEDs 1 & 2 are solid red.)

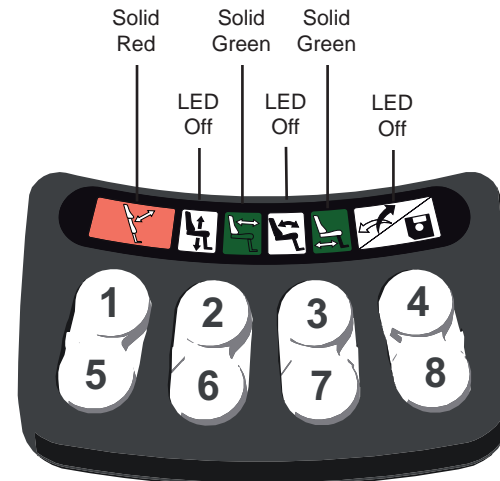

The indications on the switchbox above communicate:

- Switches 1 & 5 will operate Standing Sequence Switch 4 will "swap" switches 2/6 & 3/7
- Switches 2 & 6 will operate the Seat Elevator (to enable operation of backrest and legrest)
- Switches 3 & 7 will operate the Tilt Switch 8 will enter "memory mode"

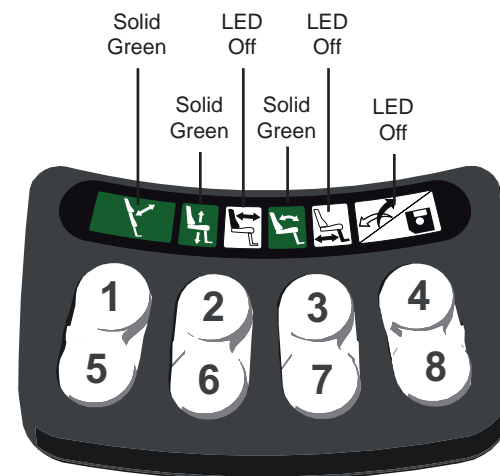

Advanced Seat Operation through Switchbox

Seat Function Memory Overview

The Seating System Power Functions can be controlled via the ICS Switchbox. The ICS Switchbox has eight switches (pushbuttons or toggles) and eight LEDs as seen below.

Depending on the Switchbox Layout that has been selected and the mode that the Switchbox is currently in, the functionality of each switch can be different.

When using the ICS Switchbox, it is important to note the Position, Color and “Light Type” (Solid/Flashing) of the LEDs that illuminate the Icons on the Switchbox.

These different characteristics communicate the current switchbox mode and which seat function a particular switch will control.

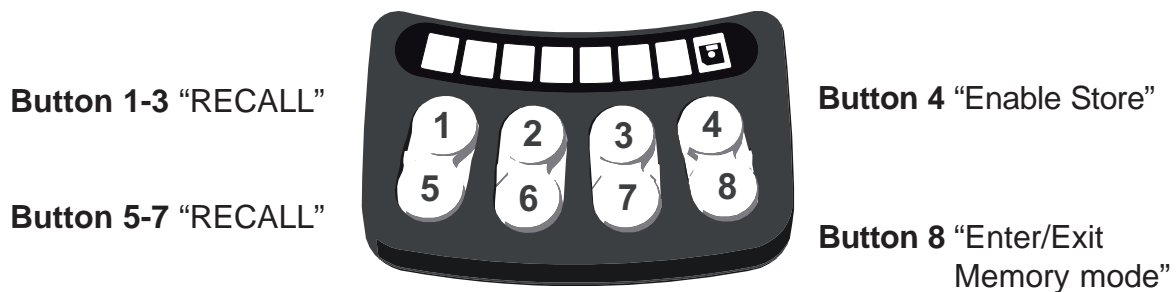

NOTE: Only Seating Functions with Precise Position Feedback (Softpot, Smart Actuator, etc.) can have their position stored and recalled using the memory function.

Seat Function Memory Step-by-Step

Storing a Seating Position into Memory

Button 5-7 “STORE”

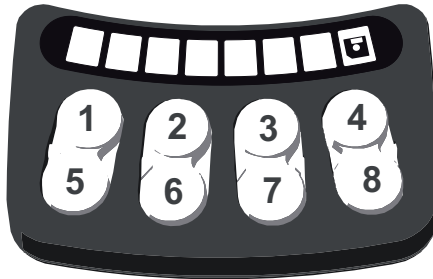

Button 4 “Enable Store”

Button 8 “Enter/Exit
Memory mode”

Before beginning:

Position the seating system in the desired position using the techniques described in the **Controlling Seat Functions** section.

This will be the position that will be **stored** using the following steps.

After the seating system is in the desired position:

1. Enter the memory mode by pressing and holding Button #8 for two seconds.
 - the floppy symbol flashes green (this signifies that you are in the memory mode)
2. Enable memory position storage by pressing and holding Button #4 for two seconds.
 - LED 7 will turn green, this signifies memory storage is activated
3. Store the position by pressing and holding one of the three store buttons (#5, #6, #7) for two seconds.
 - a short beep will sound and the LED above the memory button briefly lights red, then changes to solid green.
4. Exit the memory mode by pressing and releasing Button #8 once.

NOTE: Only Seating Functions with Precise Position Feedback (Softpot, Smart Actuator, etc.) can have their position stored and recalled using the memory function.

Seat Function Memory Step-by-Step

Recalling a Seating Position from Memory

Button 1-3 “RECALL”

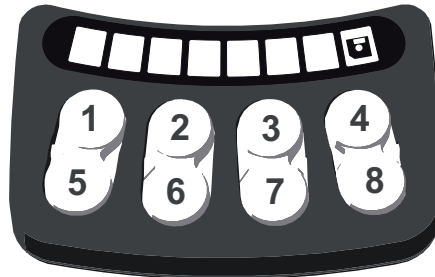

Button 8 “Enter/Exit
Memory mode”

1. Enter the memory mode by pressing and holding Button #8 for two seconds.
 - the floppy symbol flashes green (this signifies that you are in the memory mode)
2. Recall the stored position by pressing and holding the recall button for the desired position (#1, #2 or #3).
 - Hold the recall button until the symbol above the button lights green. This confirms the memory position has been reached and all actuator movement is stopped.
NOTE: The button can be released at any time to stop actuator movement.
3. Exit the memory mode by pressing and releasing Button #8 once.

NOTE: Only Seating Functions with Precise Position Feedback (Softpot, Smart Actuator, etc.) can have their position stored and recalled using the memory function.

Basic Seat Operation through R-net Control Panel

Seating System movement can be performed using the Joystick in the Control Panel that operates the wheelchair drive motors.

Seating Control is accessed via the MODE button on the Control Panel. Press and release the MODE button until the seating system icon appears in the LCD display.

Once the Seating System Icon appears on the LCD display, push the joystick left or right to select the seating function you wish to control.

Once the desired seating function is displayed on the LCD, push the joystick forward or backward to operate the seating function.

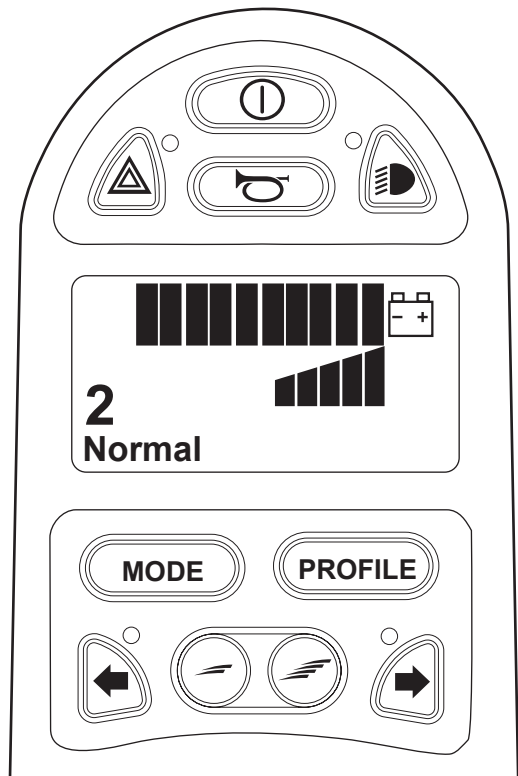

Press Mode Button to access Seat Menu

Below is an example of the icons that can be used to control a typical Corpus seating system. The seating system icons that are displayed in the LCD will vary by seating system and installed options.

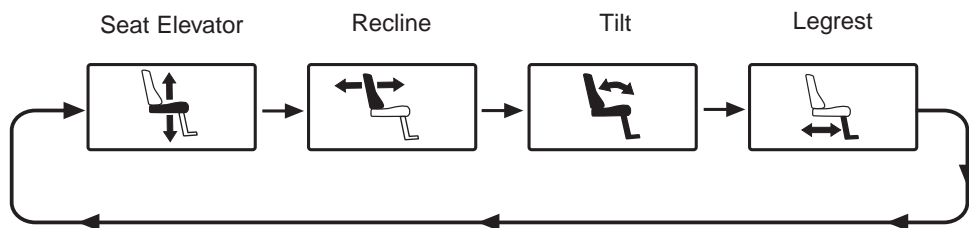

Below is an example of the icons that can be used to control a typical VS seating system. The seating system icons that are displayed in the LCD will vary by seating system and installed options.

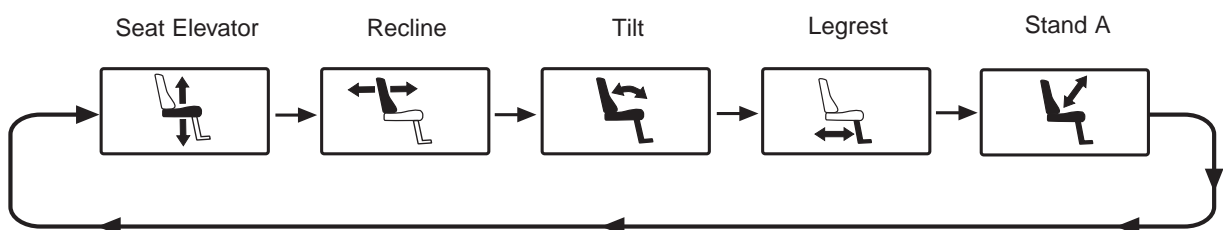

Advanced Seat Operation through R-net Control Panel

Recalling a Seat Position from Memory

Seat Position Memories can be recalled using the Joystick in the Control Panel that operates the wheelchair drive motors. The Seat Position Memories are part of the Seating Control Mode.

Seating Control Mode is accessed via the MODE button on the Control Panel. Press and release the MODE button until the seating system icon appears in the LCD display.

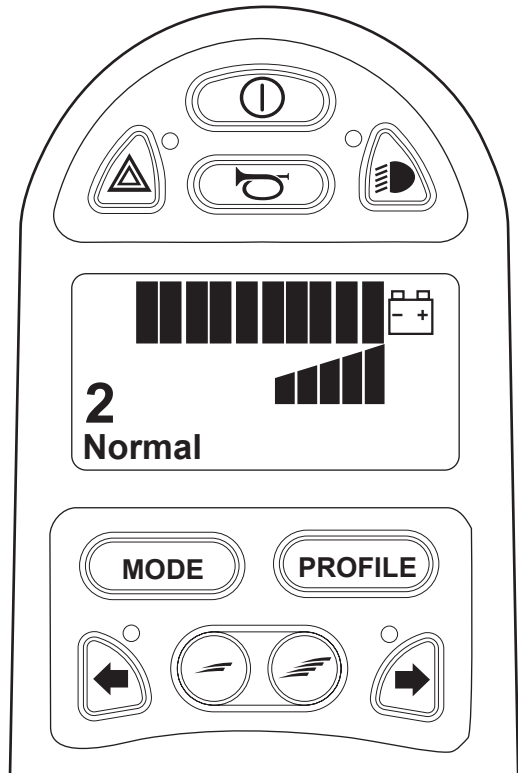

Press Mode Button to access Seat Menu

Once the Seating System Icon appears on the LCD display, push the joystick left or right to select the memory location you wish to recall. The memory recall icons are “after” the regular seat function icons.

Memory Position 1 Memory Position 2 Memory Position 3



NOTE: Memory Recall through the R-net JSM must be enabled via Wheelchair Builder before memory can be accessed using the R-net Joystick Module.

Once the desired memory location is displayed on the LCD (Memory 2 in this example), push the joystick forward to move the seat to the memorized position.

When actuator movement stops, the seating system has reached the stored position.

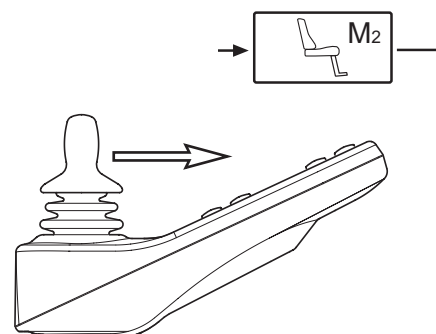

Push the joystick forward to move the seat to the memorized position.

Storing a Seat Position into Memory

Seat Position Memories can be stored using the Joystick in the Control Panel that operates the wheelchair drive motors. The Seat Position Memories are part of the Seating Control Mode.

Seating Control Mode is accessed via the MODE button on the Control Panel. Press and release the MODE button until the seating system icon appears in the LCD display.

NOTE! Before storing a seating position, it is important that the seat is in the position you wish to be memorized. Position the seat (via the ICS Switchbox or R-net Joystick) before continuing below.

Once in the Seating Mode, push the joystick left or right to select the memory location you wish to recall.

The memory recall icons are “after” the regular seat function icons.

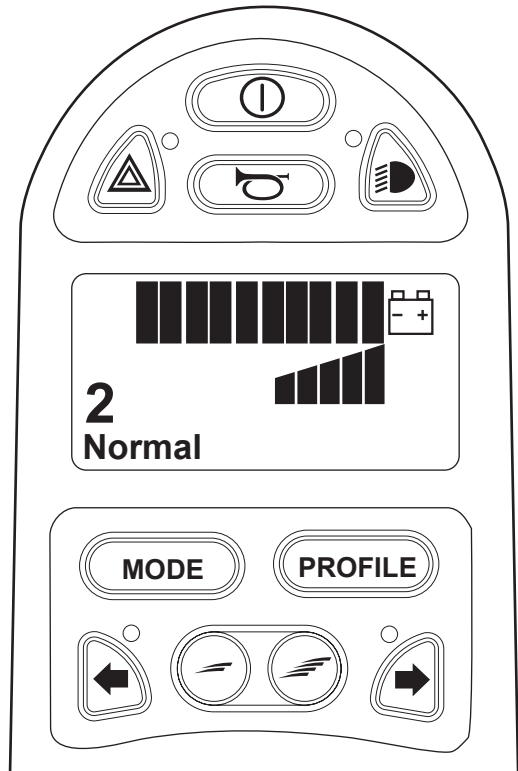

Press Mode Button to access Seat Menu

Memory Position 1 Memory Position 2 Memory Position 3



NOTE: Memory Recall through the R-net JSM must be enabled via Wheelchair Builder before memory can be accessed using the R-net Joystick Module.

Once the desired memory location is displayed on the LCD (Memory 2 in this example), pull the joystick backward to “enable” storing into this memory location. An arrow is displayed next to the M once “enabled”.

Complete the store process by pushing the joystick forward. Keep holding forward until the “store” arrow disappears. When the arrow is no longer visible, the seat position was successfully stored.

If the store process was entered by mistake, simply do not give a forward command to complete the process. After 10 seconds, the memory mode will be exited and the R-net Joystick’s display will return to the first seat function (typically Seat Elevator.)

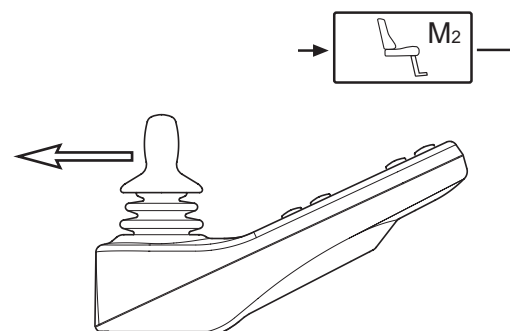

Pull the joystick backward to “enable” storing into this memory location.

Standing Function

(Only applies to VS Seat)

The VS Seating System is capable of transitioning from a seated or partially reclined position to a fully standing position via the use of an ICS Switchbox button or through the Control Panel.

Standing Operation through Switchbox

Using the ICS Switchbox to operate the Standing Sequence with Layout 2:

- Switch 1 will move the Standing Sequence UP (to Stand the Chair)
- Switch 5 will move the Standing Sequence DOWN (to unStand the Chair)

For clarity, LEDs for other switches are not shown in this example.

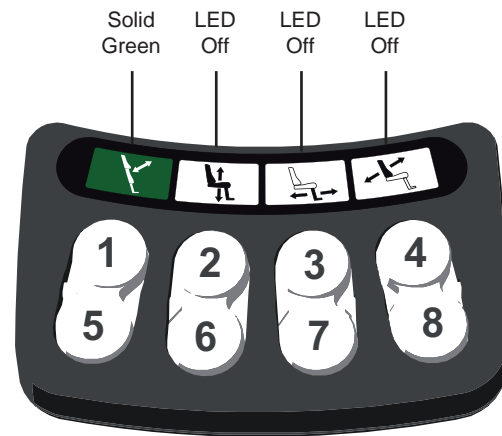

Using the ICS Switchbox to operate the Standing Sequence with Layout 3:

- Switch 1 will move the Standing Sequence UP (to Stand the Chair)
- Switch 5 will move the Standing Sequence DOWN (to unStand the Chair)

For clarity, LEDs for other switches are not shown in this example.

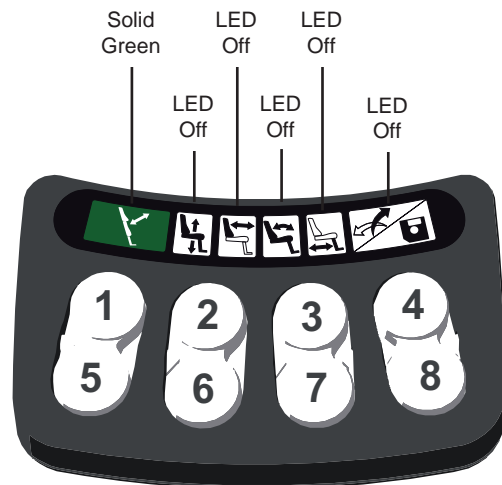

Using the ICS Switchbox to operate the Standing Sequence with Layout 4:

- Switch 1 will stand the chair according to Standing Sequence 'A'
- Switch 5 will unstand the chair according to Standing Sequence 'A'

For clarity, LEDs for other switches are not shown in this example.

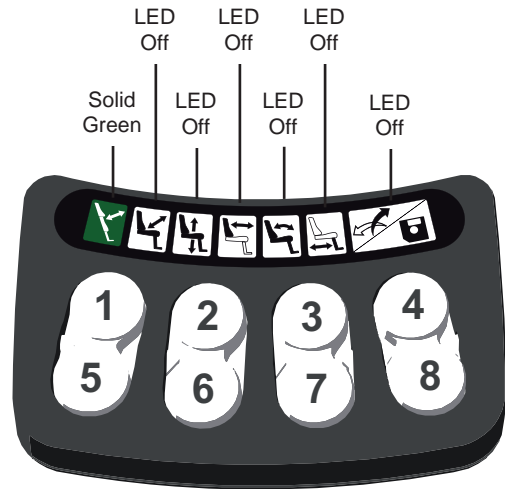

- Switch 1 will stand the chair according to Standing Sequence 'B'
- Switch 5 will unstand the chair according to Standing Sequence 'B'

For clarity, LEDs for other switches are not shown in this example.

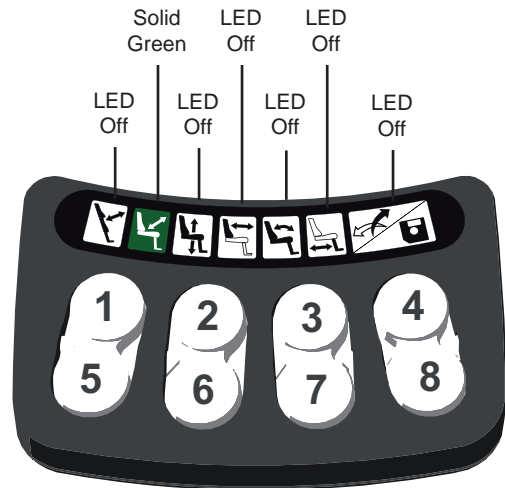

Standing Operation through Pilot+ Joystick (VS seat only)

Seat Movement of the VS Seating System can be performed through the Joystick in the Control Panel used to operate the wheelchair's drive motors.

Seating Control is accessed via the MODE button on the Control Panel. Press and release the MODE button until one or more LEDs illuminate in the wheelchair graphic printed on the Control Panel.

Once the Red LEDs illuminate in the wheelchair graphic on the Control Panel:

- Use 'Left' or 'Right' Joystick Commands to illuminate the appropriate LED combination for the Seat Function you wish to operate.

Once the desired seat function is illuminated:

- push the Joystick 'Forward' to move that function Forward/Up.
- push the Joystick 'Backward' to move that function Backward/Down.

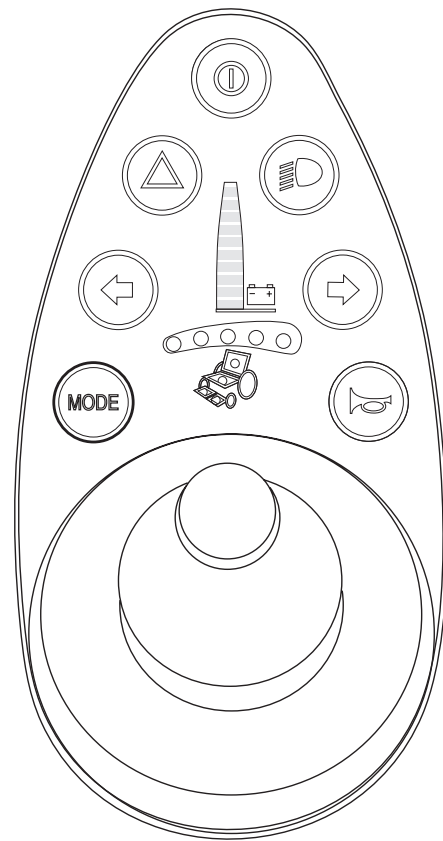

Pilot+ Joystick.

Chapter 2 - Programming

General

The Intelligent Control System (ICS) needs to be configured to meet the user's needs when the chair is first delivered. Additionally, configuration changes may need to be made if the end-user's conditions or needs change.

ICS Switchbox Programming

The most common programming steps can be performed using the ICS Switchbox installed on the wheelchair; this requires that the switchbox be placed into a special programming mode to adjust the desired parameters.

The switchbox is placed into the programming mode by pressing and holding a combination of switchbox buttons while the wheelchair is powered on. Each programming mode uses a specific combination of buttons, this information is described at the beginning of each set of programming instructions on the following pages.

It is suggested that you read through the programming instructions for a specific parameter completely before beginning the programming process.

R-net control panel programming

In addition, a number of ICS system settings can be configured using R-net's OBP function. In order to use OBP, there must be a display on the system control panel (or an OMNI). To enable OBP, a programming key (R-net dongle) must be connected to the R-net system. It is then possible to configure certain ICS system settings using the R-net control panel's buttons and joystick. These settings expand on the settings configured using the ICS Switchbox. These settings are described in the section entitled "Configuring ICS through R-net control panel" on pages 48-53.

PC Programming

It is also possible to configure the ICS system using a PC based software application created by Permobil.

To use a PC to configure the ICS system in a wheelchair, you must have the necessary software and cabling.

A separate technical manual discusses how to use Wheelchair Builder to program the ICS system.

Configuring using the ICS Switchbox

Global Settings

These Settings are available on every wheelchair equipped with ICS.

Selecting a User Weight Range

The ICS System must be programmed with the user's weight in order to provide the safest and most reliable configuration possible. The user weight information is used to limit the maximum position of some actuators, resulting in a more reliable seating system and a safer overall product configuration.

The correct weight range must be chosen

To set the User Weight Range:

To enter the User Weight Entry mode, the system needs to be started up with a combination of pressed buttons: Press and hold Button 2 and Button 4 on the ICS Switchbox, while holding these buttons, turn on the wheelchair with the Power Button on the Joystick (or Input Device).

Once all LEDs on the ICS Switchbox turn green, release Buttons 2 and 4.

- LED #8 will flash RED to signify User Weight Entry mode.

The user weight range is represented with LEDs 1, 2, 3, 4 on the ICS Switchbox.

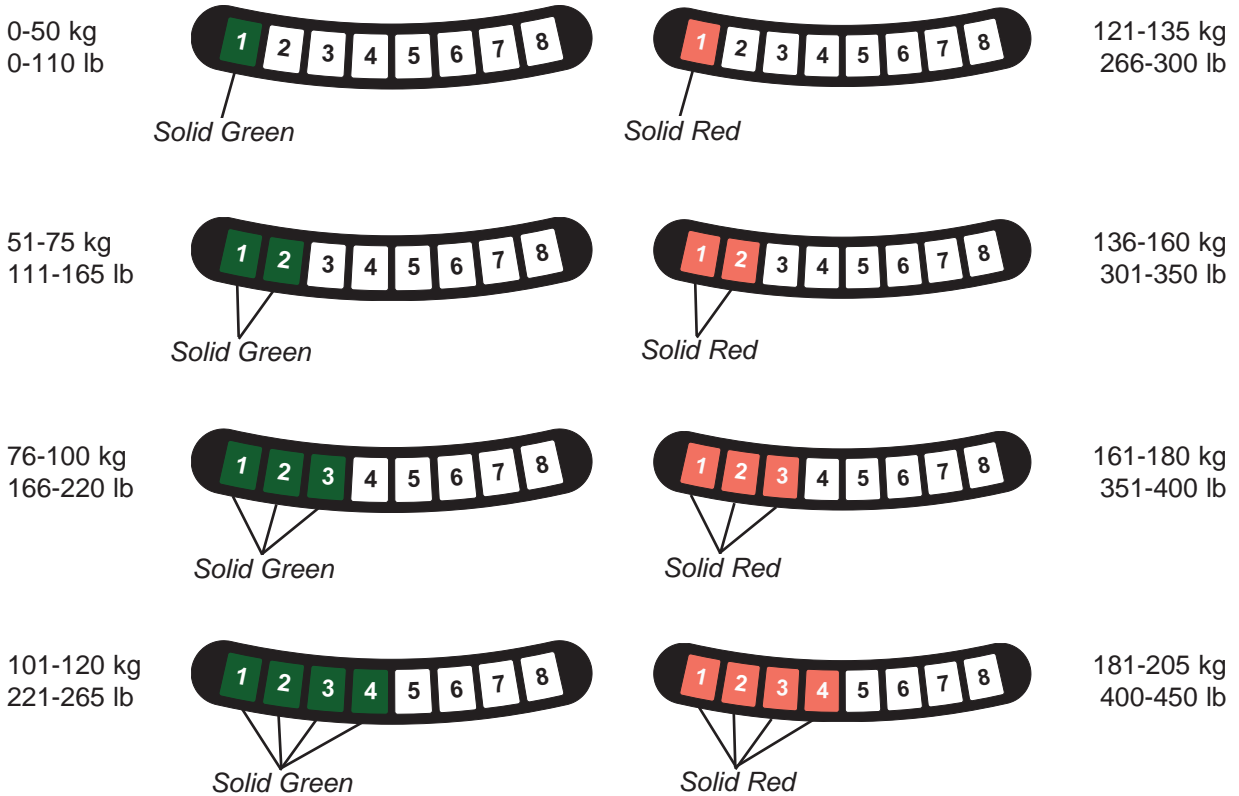

NOTE! Not all Seating Systems can support the weight ranges shown.

Once in the User Weight Entry mode, the current User Weight setting will be displayed. Find the appropriate weight range in the chart above and select this range using Button 1 and 5.

Press Button 1 to increase the Weight Range or Button 5 to decrease the Weight Range.

After the appropriate weight range is displayed with the LEDs, press and hold Button 8 for two seconds to save the setting.

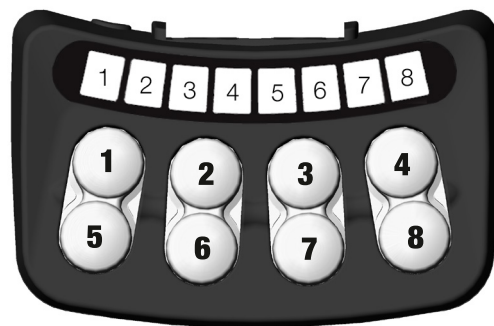

Selecting the LED Indication Level

This programming mode is the same as the User Weight Entry mode. As such, this setting can be completed at the same time.

The type of indication that is given by the LEDs inside the ICS Switchbox can be adjusted. If perhaps, a user is easily distracted by the flashing indications, these can be hidden by selecting Indication Level 2.

NOTE: Flashing RED LEDs (Actuator Errors) are displayed in every Indication Level.

Available LED Indication Levels:

Level 1	All LEDs off.	No indications. (Use with "single page" layouts.)
Level 2	Only displays Green LEDs	No indication of Drive Speed or Actuator Limits.
Level 3	Only displays Solid LEDs	No indication of Actuator Limits (Only Drive Speed.)
Level 4	All Indications Displayed	(Default Setting)

NOTE: Flashing RED LEDs (Actuator Errors) are displayed in every Indication Level.

To set the LED Indication Level:

To enter the Indication Level Selection mode, the system needs to be started up with a combination of pressed buttons: Press and hold Button 2 and Button 4 on the ICS Switchbox, while holding these buttons, turn on the wheelchair with the Power Button on the Joystick (or Input Device).

Once all LEDs on the ICS Switchbox turn green, release Buttons 2 and 4.

- LED #8 will flash RED to signify Indication Level Selection mode.

The LED Indication Level is represented with LEDs 5, 6 on the ICS Switchbox.

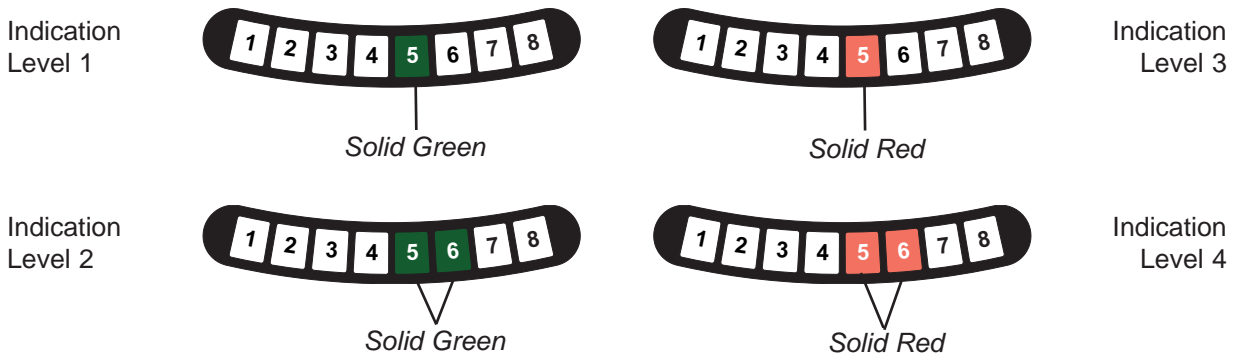

Once in the Indication Level Selection mode, the current indication level setting will be displayed. Find the desired indication level in the chart above and select this range using Button 3 and 7.











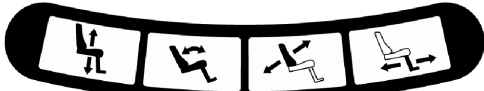
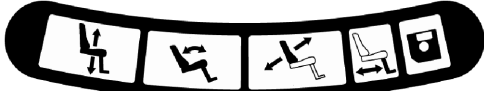

Press Button 3 to increase the Indication Level or Button 7 to decrease the Indication Level.

After the appropriate indication level is displayed with the LEDs, press and hold Button 8 for two seconds to save the setting.



Switchbox Label Sheet

For ease of programming, the Layout Numbers for each Label included in Part Number 1822329 are shown.

	A	Corpus II & Corpus 3G – Layout 1 Corpus APE & Corpus VS – Layout 1 RS – Layout 3 PS – Layout 1
	B	Corpus II & Corpus 3G – Layout 2 Corpus APE & Corpus VS – Layout 2 RS – Layout 4 PS – Layout 2
	C	Corpus II & Corpus 3G – Layout 3 Corpus APE & Corpus VS – Layout 3
	D	Corpus II & Corpus 3G – Layout 4 Corpus APE & Corpus VS – Layout 4 VS – Layout 1 PS – Layout 3
	E	VS – Layout 2 Corpus APE & Corpus VS – Layout 5
	F	VS – Layout 3 Corpus APE & Corpus VS – Layout 6
	G	VS – Layout 4 Corpus VS – Layout 7
	H	RS – Layout 1
	I	RS – Layout 2
	J	K450 MX – Layout 1
	K	K450 MX – Layout 2
	L	Corpus II & Corpus 3G - Layout 7 Corpus APE & Corpus VS – Layout 12
	M	Corpus II & Corpus 3G - Layout 5 Corpus APE – Layout 13

Choosing a Switchbox Layout

The ICS System offers several Switchbox Layouts for each Seating System. These Layouts enable the Switchbox functionality to be tailored to suit the user.

When changing the Switchbox Layout, first select the desired layout number from the table on the next page, then proceed with the programming instructions below. Only layouts designed for a seating system are able to be chosen on that seating system.

To enable layout changes once a wheelchair is in the field, a label sheet is available with all layout stickers, part number 1822329 can be ordered as a Spare Part. It is suggested that the appropriate label be applied to the Switchbox after the layout has been programmed and its operation is confirmed.

To change the Switchbox Layout







1. Enter the Switchbox Layout Selection mode:

- a) With the wheelchair off, press and hold Button 1 and Button 3 on the ICS Switchbox.
 - b) While holding these buttons, turn on the wheelchair with the Joystick (or Input Device) Power Button.
 - c) Once all LEDs on the ICS Switchbox turn green, release Buttons 1 and 3.
- LED #7 will flash GREEN and LED #8 will glow RED to signify Switchbox Layout Select mode.

2. Adjust Layout Number to desired Layout type:

- a) Once in the Switchbox Layout Selection mode, the current layout setting will be displayed.
 - b) Find the desired layout in the chart below. Select this value using Button 1 and 5 on the switchbox.
- Button 1 will increase the layout selection and Button 5 will decrease the layout selection.

The Switchbox Layout is represented with LEDs 1, 2, 3, 4, 5 on the ICS Switchbox.

Number of lit LEDs	Solid Green	Solid Red	Solid Yellow
	Layout 1	Layout 7	Layout 13
	Layout 2	Layout 8	Layout 14
	Layout 3	Layout 9	Layout 15
	Layout 4	Layout 10	Layout 16
	Layout 5	Layout 11	Layout 17
	Layout 6	Layout 12	Layout 18

3. Save the desired setting:

- a) When the setting matches the desired Layout Number, press and hold Button 8 for two seconds to save.
 - b) Turn off the wheelchair to exit the Switchbox Layout Selection mode.
 - c) Turn the wheelchair back on and confirm the switchbox operates as desired. If not, repeat the process.
- If the wheelchair is fitted with multiple switchboxes, the process above must be completed using each switchbox that changes are desired on.

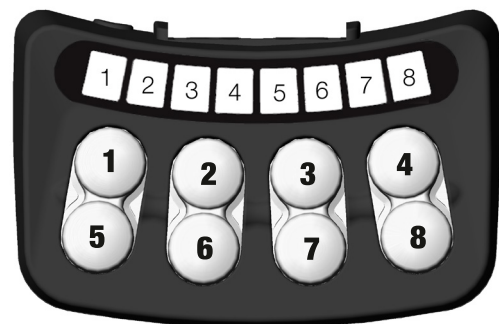

Other general settings

These functions are available with ICS config. files released after October 15, 2010 and apply for the majority of seat types.

All the function settings specified below are initiated by the following process:

1. Switch off the wheelchair by pressing the start key on the R-net control panel.
2. You must press and hold a combination of buttons on the ICS Switchbox while powering up the wheelchair. Press and hold buttons 2, 7 and 8 on the ICS Switchbox while powering up the wheelchair by pressing the start key on the control panel.

The ICS Switchbox buttons can be released once all its LEDs light up green. You can now access page 1 of the Set-up settings.

LEDs 7 and 8 alternately flash green, which indicates that Set-up mode has been activated and that page 1 in the Set-up menu has been selected.

It is now possible to choose a set-up function. The buttons used have a toggle function, i.e. each time you press one it switches between the two settings.

If you are on page 1 in the Set-up menu and want to access page 2, press button 4.

If you are on page 2 in the Set-up menu and want to access page 3, press button 4.

If you are on page 2 or 3 in the Set-up menu and want to return to previous page, press button 8.

Page 1 is visible when LEDs 7 and 8 alternately flash green.

Page 2 is visible when LED 7 flashes green.

Page 3 is visible when LED 8 flashes green.



Settings on page 1 in the Set-up menu

Blocking actuator movement during operation.

To adjust the degree of actuator movement during operation of the wheelchair, press button 1.

When LED 1 lights up green, all actuators are blocked during operation.

When LED 1 lights up red, all actuators are unblocked during operation.

Low back installed.

To specify whether a low back has been installed on the wheelchair, press button 5. This limits the maximum back angle.

When LED 2 lights up green, a low back is installed.

When LED 2 lights up red, no low back is installed.

Adapter for -5° tilt installed.

To specify whether this adapter has been installed or not, use button 2.

When LED 3 lights up green, the adapter for -5° tilt is installed.

When LED 3 lights up red, no adapter for -5° tilt is installed.

Introducing a tilt pause at 0° position

To specify whether there should be a short pause in tilting on reaching the 0° position, press button 6. This function is only appropriate for chairs with an adapter for -5° tilt.

When LED 4 lights up green, there will be a pause in the tilt movement.

When LED 4 lights up red, there will be no pause in the tilt movement.

Pausing the legrest actuator in speed reduction mode

To specify whether the legrests temporarily stop before entering or leaving the range at which the wheelchair's speed is reduced because of the legrest positions, press button 3.

This function is only appropriate for chairs with front casters.

When LED 5 lights up green, the legrests will pause.

When LED 5 lights up red, the legrests will not pause.

Settings on page 2 in the Set-up menu**Keeping the legrests within the permitted range during tilt**

To specify whether the legrests are to be kept within the max. or min. position automatically during tilt, press button 1.

If this function is enabled, the legrest angle during tilt will be changed to ensure it does not exceed the max. or min. position.

When LED 1 lights up green, the legrest position remains within the permitted range during tilt.

When LED 1 lights up red, tilt stops when the legrest angle reaches the max. or min. position.

Keeping the backrest within the permitted range during tilt

To specify whether the backrest is to be kept within the max. or min. position automatically during tilt, press button 5.

If this function is enabled, the angle of the backrest to the seat plane during tilt will automatically be changed when the backrest reaches the max. or min. position.

When LED 2 lights up green, the backrest position remains within the permitted range during tilt.

When LED 2 lights up red, tilt stops when the backrest angle reaches the max. or min. position.

Inverting the elevator direction through the switchbox

To adjust whether the direction of the elevator will be inverted when operated with the ICS switchbox, press button 2.

- When LED 3 lights up green, the elevator will move up when the rear button is activated.
- When LED 3 lights up red, the elevator will move up when the front button is activated. (standard).

Inverting the tilt direction through the switchbox

To adjust whether the direction of the tilt will be inverted when operated with the ICS switchbox, press button 6.

- When LED 4 lights up green, the tilt will move forward when the rear button is activated.
- When LED 4 lights up red, the tilt will move forward when the front button is activated. (standard).

Inverting Recline direction through the switchbox

To adjust whether the direction of the recline will be inverted when operated with the ICS switchbox, press button 3.

- When LED 5 lights up green, the recline will move forward when the rear button is activated.
- When LED 5 lights up red, the recline will move forward when the front button is activated. (standard).

Inverting Legrest direction through the switchbox

To adjust whether the direction of the legrest will be inverted when operated with the ICS switchbox, press button 7.

- When LED 6 lights up green, the legrest will move up when the rear button is activated.
- When LED 6 lights up red, the legrest will move up when the front button is activated. (standard).

Settings on page 3 in the Set-up menu

Link Legrest to Backrest movements

To link the movement of the legrest to the movement of the backrest (legrest moving outwards when backrest is moving backwards and vice versa) press button 1.

- When LED 1 lights up green the legrest is linked to the backrest movements.
- When LED 1 lights up red the legrest isn't linked to the backrest movements.

NOTE! In both settings, the leg rest can be adjusted on its own without influence on the backrest.



Corpus II - Specific Attributes

Setting Legrest Angle for Speed Reduction

When the Corpus Seat is mounted on a rear-wheel drive chassis (e.g. C350, Street) it is necessary to specify the legrest angle that positions the footplates near the front casters. This legrest angle will limit the speed of the wheelchair to approximately 1/4 of the maximum driving speed. The speed is reduced at this position to prevent the casters from striking the footplates at high speeds.

NOTE: If this setting is incorrect, it may be possible for the casters to collide with the footplates when the chair is driving at full speed. This may result in damage to the casters and/or footplates and could cause personal injury.

To change the Legrest Angle for Speed Reduction value:

To enter the Legrest Angle for Speed Reduction Selection mode, the system needs to be started up with a combination of pressed buttons: Press and hold Button 1, 2 and 7 on the ICS Switchbox, while holding these buttons, turn on the wheelchair with the Power Button on the Joystick (or Input Device).

Once all LEDs on the ICS Switchbox turn green, continue to hold Buttons 1, 2 and 7 for five seconds.

- LED #7 flashes RED and LED #8 flashes GREEN to signify Legrest Angle Selection mode has been entered.

Release Buttons 1, 2 and 7.

The current parameter value is represented with LEDs 1, 2, 3, 4, 5 on the ICS Switchbox.

Press Button 1 or Button 5 to change the value of the legrest angle that limits the driving speed.

After the appropriate value is displayed with the LEDs, press and hold Button 8 for two seconds to save the setting, this will also exit the programming mode. Turn the wheelchair off and back on to continue normal usage.

The angle values shown in the table above represent the angle that the legrest must be elevated greater than to allow full speed driving of the chassis. For example, if the three LED setting is selected and the legrest angle is raised less than 9°, the chair will drive at at reduced speed speed.

When the legrest is limiting the drive speed, the switchbox icon for the legrest function will be illuminated with a solid yellow LED – unless LED Indication Level 1 or 2 is programmed.

The R-net Joystick also displays a solid turtle in its LCD when the wheelchair speed is limited.

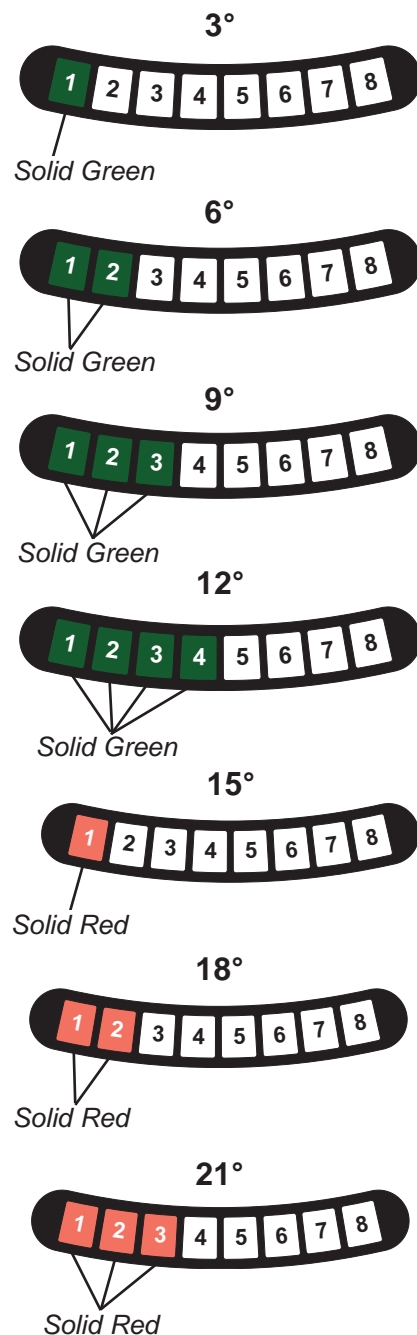

45° Tilt calibration C400/C500 Corpus

This feature is available from version v.24 of ICS config.file for C400/C500 Corpus, released June 2010.

This calibration method is only valid on C400/C500 Corpus with 45° tilt installed.

If the seat frame doesn't reach the rubber pads or if the seat frame goes too hard on them when fully untilted, there is a need for tilt calibration. This is accomplished by fine tuning the untilted position as described below.

1. Turn off the wheelchair.
2. The system needs to be started up with a combination of pressed buttons: Press and hold Button 5, 6 and 3 on the ICS Switchbox, while holding these buttons, turn on the wheelchair with the Power Button on the Control Panel (or Input Device).

Once all LEDs on the ICS Switchbox turn green, release Buttons 5, 6 and 3.

LED #7 and #8 will toggle RED to signify Actuator Calibration mode.

3. To move the tilt into its current untilted position, press and hold Button 2 until the tilt stops moving or the seat frame touches the rubber pads.

If the tilt needs to go down a little more, press and hold button 3 until desired position is reached.

If the tilt needs to go down a little less, press and hold button 7 until desired position is reached.

4. Verify the new untilted position by operating the tilt with button 2 and 6 and if more adjustment is needed go back to step 3.

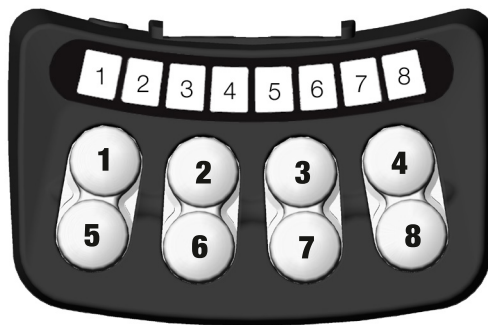

Corpus 3G/HD/APE/VS - Specific Attributes

IRM - Independent Repositioning Mode

The IRM-function has been designed to make it possible for the user to regain the best seated position with the whole back leaning against the backrest. The function consists of two parts. First a movement (A) which makes the user lean back and slide towards the back rest. Then a movement (B) which puts the user in to a normal seated position with the whole back against the back rest.

The end position of both movements can be adjusted to suit the user.

When the IRM-function has been activated it replaces Memory position 3.



IRM Setup

Setup is performed using the following key sequences on the ICS control panel.

Activation / deactivation of the IRM

- With the power turned off, press button 2, 7 and 8 on the ICS control panel.
- Turn the power on by pressing the start button on the wheelchair's control panel. ICS-control panel buttons can be released when all the LEDs are lit green.

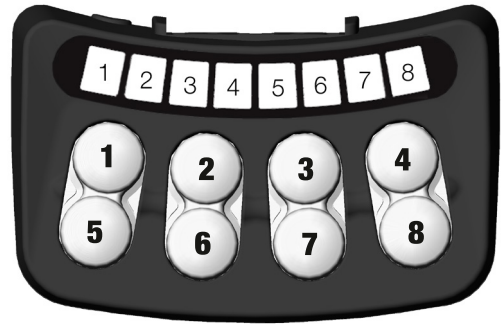

- LED 7 and 8 will now flash green.



- To enable IRM on the wheelchair:
 - Press the button 7 until LED 6 lights green.
 - Turn the wheelchair "Off".
- To turn the option of using IRM off.
 - Press the button 7 until LED 6 lights red.
 - Turn the wheelchair "Off" by pressing the start button on the wheelchair's control panel.



Setting the IRM-positions

Setting the maximum rear position and the end position after the seats motion forward is performed as follows.

- With the power turned off, press button 5 and 7 on the ICS control panel.
- Turn the power on by pressing the start button on the wheelchair's control panel. ICS-control panel buttons can be released when all the LEDs are lit green.
- LED 8 is now flashing red / green.
- For Corpus APE and Corpus VS only:
 - Press button 7. Led 7 will lit solid green
- Maneuver the seat to the desired rear end position:
 - Button 1 and 5 controls seat tilt function.
 - Button 2 & 6 controls the leg rest.
 - Button 3 & 7 controls the back rest.
- Press the button 4 to save position.
- Maneuver the seat to the desired front end position
 - With 1 button and 5 runs seat tilt function
 - The Key 2 & 6 runs legrest
 - With key 3 & 7 running back rest
- Press the button 8 to save position.
- Turn the power "Off" by pressing the start button on the wheelchair's control panel.

The user's handling of the IRM

Method A) Via ICS control panel with "memory mode":

- Hold Press and hold button 8 to enter the memory mode. LED 8 is blinking green.
- Press and hold button 3 to move the seat to it's rear position.
- (If needed, help the body to slide towards the back rest.)
- Press and hold button 7 to move the seat to the front end position.
- Press and hold button 8 to exit the memory mode.



Method B) Via R-net Control Panel or OMNI:

Joystick is here specified as an example, but it could be any other available control unit.

NOTE! The icon 'Recall Memory 3' must be set for display on the display (see section "Configuring ICS via the R-net Control Panel").

- Go to Seating Mode.
- Use the Joystick to toggle the function until the M3 icon is shown on the display.
- Move the joystick forward to move the seat to it's rear position.
- (If needed, help the body to slide towards the back rest.)
- Move the joystick backwards to move the seat to the front end position.
- Leave Seating Mode.

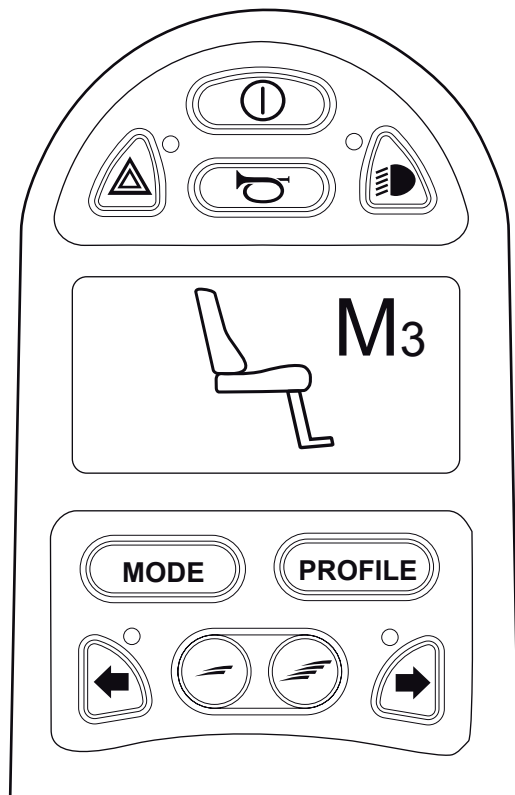

Setting of Corpus 3G/HD/APE/VS Seat Depth

The correct seat depth has to be set in the ICS to make the leg rest stop in the right position and not collide with the chassis and to reduce the speed on chassis with front casters when the foot plates are in the vicinity of the castors. On delivery of the wheelchair, this is already done but when the seat depth changes or if the control system is reprogrammed / updated setting of the seat depth could be needed after delivery. It is performed as follows:



1. To enter the Seat Depth Selection mode:

- a) With the wheelchair off, press and hold Buttons 3, 4 & 6 on the ICS Switchbox
- b) While holding these buttons, turn on the wheelchair
- c) When all LEDs on the ICS Switchbox turn green, release the buttons.
LED #7 will flash GREEN and LED #8 will flash RED to denote Seat Depth Selection mode

2. Select the desired Seat Depth Setting:

- a) Once Seat Depth selection mode, the current setting will be displayed
- b) Select the desired value using Button 1 and 5 on the switchbox
Button 1 will increase and button 5 will decrease the setting

3. Save the desired setting:

- a) When desired setting is displayed, press and hold Button 8 for two seconds to save.
- b) Cycle power on the wheelchair and verify that the seat operates as desired. If not repeat the process.

Seat Depth	Indication at setting of Seat Depth	
470mm (18") or shorter		1. Solid green 7. Flashing green 8. Flashing red
495mm (19")		1-2. Solid green 7. Flashing green 8. Flashing red
520mm (20")		1-3. Solid green 7. Flashing green 8. Flashing red
545mm (21")		1-4. Solid green 7. Flashing green 8. Flashing red
570mm (22")		1-5. Solid green 7. Flashing green 8. Flashing red
595mm (23")		1-6. Solid green 7. Flashing green 8. Flashing red
620mm (24")		1. Solid red 7. Flashing green 8. Flashing red

Corpus 3G on M300/M400 and C350 Corpus HD on M300/M400

Adjusting Legrest Angle for Full-Speed Driving

When the Corpus 3G Seating System is mounted to a Power Base that has front casters, it is possible for the footplates to interfere with the swiveling of those casters. In order to prevent injury to the user or damage to the casters and/or footplates, the wheelchair's driving speed is automatically reduced when the footplates could interfere with the casters.

However, since each user's needs are different, it is possible to fine tune the angle at which this automatic speed reduction occurs. The instructions on the next two pages explain the adjustments that can be made to affect the legrest speed reduction angle.

It is recommended that the "offset" value be adjusted first to try to reach the legrest angle that accommodates the user's needs for full speed driving. However, if full-speed driving is required with a 90° legrest angle, the "offset" value and the "seat depth" value will likely need adjustment.

⚠ NOTE!

When the legrest angle is limiting the drive speed, the switchbox icon for the legrest function will be illuminated with a solid yellow LED – unless LED Indication.

The R-net Joystick (or Omni) also displays a solid turtle in its LCD when the wheelchair speed is limited. To determine if the legrest angle is creating this limitation, change to Seating mode and scroll to the legrest function.

If the legrest is flashing, the legrest angle is limiting the driving speed.



When the legrest angle is limiting the drive speed, the switchbox icon for the legrest function will be illuminated with a solid yellow LED – unless LED Indication.



Adjusting Legrest Angle “offset” for Speed Reduction

When the Corpus 3G Seat is mounted on a power base with front casters (e.g. M300) it is necessary to limit the speed of the wheelchair to approximately 1/4 of the maximum driving speed when the footplates could come in contact with the front casters. The seat depth setting determines this angle, but it can be fine tuned for the user’s lower leg length using an offset. A positive offset value is added to the setting defined by the seat depth, resulting in the legrest needing to be elevated more to allow full speed driving. A negative offset value is subtracted from this setting, allowing the legrest to be pulled in tighter to the base before the speed restriction occurs.

⚠ NOTE!

If this setting is incorrect, it may be possible for the casters to collide with the footplates when the chair is driving at full speed. This may result in damage to the casters and/or footplates and could cause personal injury.

Changing the Legrest Angle offset

1. Enter Legrest Angle Offset Adjustment mode:

- a) With the wheelchair off, press and hold Buttons 1, 2 & 7 on the ICS Switchbox.
- b) While holding these buttons, turn on the wheelchair with the Joystick (or Input Device).
- c) When all LEDs on the ICS Switchbox turn green, release buttons 1, 2 & 7.

LED #7 will flash RED and LED #8 will flash GREEN to denote Legrest Angle Offset Adj mode.

2. Select the desired Offset value:

- a) Once in Legrest Angle Offset Adjustment mode, the current setting will be displayed.
- b) Select the desired value using Button 1 and 5 on the switchbox.

Button 1 will increase the setting and Button 5 will decrease the setting.

3. Save the desired setting:

- a) When the desired setting is displayed, press and hold Button 8 for two seconds to save.
- b) Turn off the wheelchair to exit Legrest Angle Offset Adj mode.
- c) Turn the wheelchair on and confirm the legrest angle that affects driving speed operates as desired. If not, repeat the process.

Offset	
+12° offset	
+9° offset	
+6° offset	
+3° offset	
0° offset	
-3° offset	
-6° offset	
-9° offset	
-12° offset	

Corpus VS/Corpus APE - Specific Attributes

Setting up Standing and Anterior tilt sequences + ground clearance

Table: Relevant adjustments for various functions/options

Adjustment	Corpus VS	Corpus APE			
		Std. Legrest	Power Transfer	-20° Functional Reach	Power Adjust Footrest
Ground Touch	X	X	X	X	X
Ground Clearance	X	X	X	X	X
Standing sequence 1	X		X	X	
Standing sequence 2	X				
Legrest Extension in standing	X		X		
Enable/Disable stand and drive	X				

The Ground Touch procedure should be performed first and might have to be redone after every mechanical adjustment of the height of the footplate! The ground Touch and Clearance adjustments are accessible from the Standing Sequence Setting Mode described below.

The ICS System allows to have up to two standing sequences active via ICS switchbox or Joystick in seating mode. Each of the standing sequences S1 and S2 has a pre-defined sequence at delivery but can very easily be manually set up via ICS switchbox.

Power transfer option for Corpus APE is using the same set up procedure as the Standing sequence 1, but the maximum anterior tilt angle is much lower and the footplate will touch ground in the final position.

To successfully setup a Standing Sequence, some or all of the steps below has to be properly completed.

Note: The procedure for settings 2- 5 may differ slightly from the descriptions below for wheelchairs delivered and programmed before May 2015.

1. Enter Standing Sequence Setting mode using the ICS Switchbox:

- Turn off the wheelchair.
- Press and hold Button 5 and Button 7 on the ICS Switchbox
- While holding these buttons turn on the wheelchair with the Power Button on the control panel (or Input Device).
- Once all LEDs on the ICS Switchbox turn green, release Buttons 5 and 7. LED #8 will be blinking RED/GREEN.

The following type of adjustments can now be selected by pressing the ICS switchbox button:

- Button 1 - Standing sequence 1
- Button 2 - Standing sequence 2
- Button 3 - Legrest extension in standing position
- Button 4 - Ground clearance adjustment (Footplate to ground)
- Button 7 - Independent Repositioning Mode IRM, refer to page 34.

How to continue after entering any of these sequences is described in the following sections.

After finalizing an adjustment, the system must be restarted and the Standing Sequence Setting mode must be entered again to continue with the next adjustment.

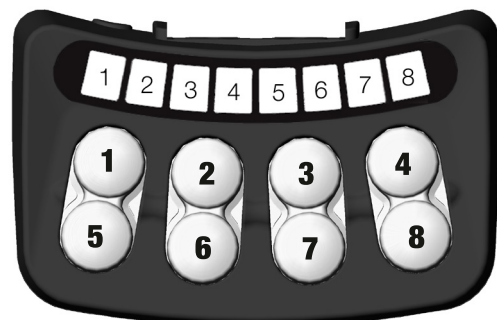

2. Standing sequence 1 adjustment (Only Corpus VS and Corpus APE options with VS legrest)

This sequence is entered by pressing Button 1 in Standing Sequence Setting mode and LED 1 is solid red until the button is released.

Note: If the button is pressed for more than 15s, the standing sequence 1 will be reset to the default standing sequence for S1. When the reset occurs, LED 1 will switch to flashing green as long as the button is activated. When the button is released, the standing sequence is reset and the chair needs to be restarted.

The following buttons are used:

- Button 1 and 5: controls standing seq. up/down (alters LED 1 and 2) Button 1 = up (raise)
- Button 2 and 6: for adjustment of the backrest angle
- Button 3 and 7: for adjustment of legrest angle
- Button 8: Save

Indications on the ICS Switchbox
(CPx = CheckPoint x)

- Led 1 - solid green: CP1 can be saved. CP1 is the highest position where the seat is still horizontal during the raising part.
- Led 2 - solid green: CP2 can be saved. CP2 is the end position for the raising sequence.
- LED 3 – solid green: CP3 can be saved. CP3 is the position during the lowering part of the standing sequence where the seat once again becomes horizontal.
- LED 4 – solid green: CP4 can be saved. CP4 is the end sitting position for the lowering part of the standing sequence.
- Led 8 - flashing green: position can be saved for stand sequence CheckPoints
- Led 8 - solid green: while holding sw8, position saved
- Led 8 - flashing red: while holding sw8, can't save sequence position

Procedure

(CPx = CheckPoint x)

1. Start from a relatively low sitting position.
2. Press Button 1 until CP1 is reached (LED 1 solid green) and adjust back rest/legrest and save
3. Press Button 1 again and the seat will start to raise. Press Button 1 until either:
 - a) LED 2 solid green – save. Press Button 1 for 5s to continue raising to wanted stand angle. Adjust Back and Leg and Save as final stand position.
 - b) max wanted stand angle is reached, adjust back/leg and save.
 - c) raise stops due to that previous endpoint is reached. Press Button 1 for 5s to continue raising to wanted stand angle. Adjust Back and Leg and Save as final stand position.
4. Press Button 5 (unstand) until CP3 is reached (LED 3 solid green) adjust back/leg and save
5. Press Button 5 until CP4 is reached (LED 4 solid green) adjust back/leg and save
6. Restart system (Off and On)!

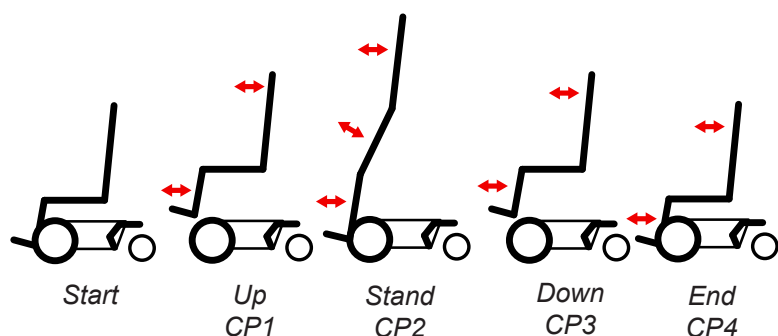

3. Standing sequence 2 adjustment (Only Corpus VS):

This sequence is entered by pressing Button 2 in Standing Sequence Setting mode and LED 2 is solid red until the button is released.

Note: If the button is pressed for more than 15s, the standing sequence 1 will be reset to the default standing sequence for S2. When the reset occurs, LED 2 will switch to flashing green as long as the button is activated. When the button is released, the standing sequence is reset and the chair needs to be restarted.

The following buttons are used:

- Button 1 and 5: controls standing seq. up/down (alters LED 1 and 2) Button 1 = up (raise)
- Button 2 and 6: for adjustment of the backrest angle
- Button 3 and 7: for adjustment of legrest angle
- Button 8: Save

Indications on ICS Switchbox

(CPx = CheckPoint x)

- Led 1 – solid yellow: CP1 can be saved. CP1 is the highest position where the seat is still horizontal during the raising part.
- Led 2 – solid yellow: CP2 can be saved. CP2 is the end position for the raising sequence.
- Led 3 – solid yellow: CP3 can be saved. CP3 is the position during the lowering part of the standing sequence where the seat once again becomes horizontal.
- Led 4 – solid yellow: CP4 can be saved. CP4 is the end sitting position for the lowering part of the standing sequence.
- Led 8 - flashing green: position can be saved for stand sequence CheckPoints
- Led 8 - solid green: while holding sw8, position saved
- Led 8 - flashing red: while holding sw8, can't save sequence position

Procedure

(CPx = CheckPoint x)

1. Start from a relatively low sitting position.
2. Press Button 1 until CP1 is reached (LED 1 is solid yellow) and adjust back rest/legrest and save
3. Press Button 1 again and the seat will start to raise. Press Button 1 until either:
 - a) LED 2 is solid yellow – save. Press Button 1 for 5s to continue raising to wanted stand angle. Adjust Back and Leg and Save as final stand position.
 - b) max wanted stand angle is reached, adjust back/leg and save.
 - c) raise stops due to that previous endpoint is reached. Press Button 1 for 5s to continue raising to wanted stand angle. Adjust Back and Leg and Save as final stand position.
4. Press Button 5 (unstand) until CP3 is reached (LED 3 is solid yellow) adjust back/leg and save
5. Press Button 5 until CP4 is reached (LED 4 is solid yellow) adjust back/leg and save
6. Restart system (Off and On)!

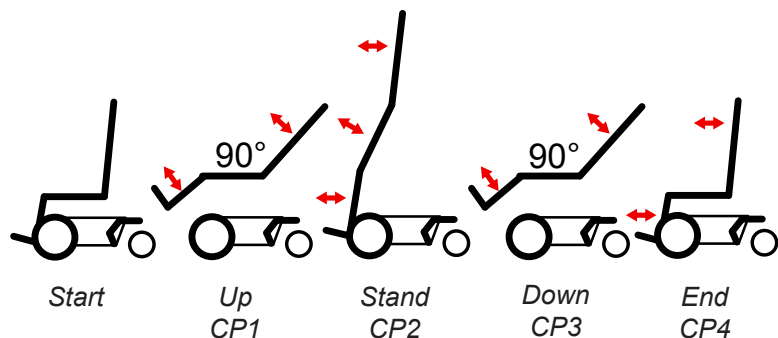

4. Adjustment of Legrest extension in standing position (Only Corpus VS and Power transfer option on Corpus APE)

This sequence is entered by pressing Button 3 in Standing Sequence Setting mode (Led 3 = solid green).

Note: If the button is pressed for more than 15s and the seat angle is not negative (angled forwards), the legrest extension will be reset to the default extension in standing position. When the reset occurs, LED 3 will switch to flashing green as long as the button is activated. When the button is re-released, the legrest extension while standing is reset and the chair needs to be restarted.

It is possible to adjust the Legrest Extension length for the standing position. This could be required to do if the legrest has extended too much (or too little) in standing position so that the user is not in a good position.

Procedure

Before entering this Legrest Extension Adjustment set up mode, use the normal standing sequence to get to the final standing position.

1. When in final standing position (CP3) and use Button 1 and 5 to adjust the position of the footplate.
2. When ready use Button 8 to save legrest extension
Led 8 - flashing green: new position can be saved
Led 8 - solid green: while holding sw8, position saved
Led 8 - solid yellow: when seat is in a position that doesn't allow saving
3. Restart system (Off and On)!
4. Return the seat to horizontal sitting position. Restart the system again (Off and On).

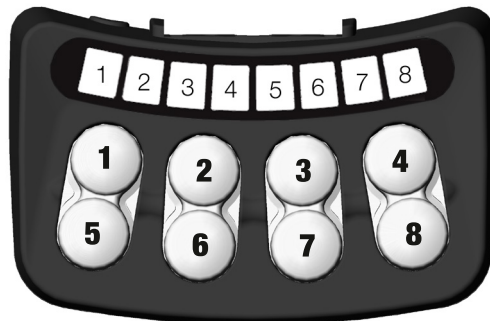

5. Ground Clearance and Ground Touch adjustments:

Both these sequences are entered by pressing Button 4 in Standing Sequence Setting mode (Led 4 = solid green, Led 8 = flashing yellow)

The Ground Clearance setting together with the Ground Touch are used by the system to maintain footplate ground clearance during standing. Ground Clearance defines how far above the Ground Touch the footplates shall be at the end of the stand sequence.

The Ground Touch setting (Corpus with articulation legrest options only) is used by the system to establish a defined position when footplates or legrest post touches ground, e.g. in order to get a correct reference when the footplates touches ground.

If footplates are mechanically adjusted below the lowest position of the legrest post it is needed to adjust the Ground Touch setting. The Ground Clearance is an offset from the Ground Touch position and is normally not needed to be adjust from default factory setting.

Ground clearance will by default be 40mm to keep footplates off the ground e.g. when standing or lowering the seat.

Note: If there is a need to get closer to the ground than currently defined Ground Clearance or Ground Touch, keep the button pressed for more than 15s and both Ground Clearance and Ground Touch adjustment is reverted to its lowest position. When the reset occurs, LED 4 will switch to flashing green as long as the button is pressed. When the button is released, the adjustments are reset and the chair needs to be restarted.

Procedure

1. When in seating position use button 1 and 5 to adjust seat elevation height or use Button 2 and 6 to adjust the position of the footplate until they touches ground (Ground Touch) or the wanted clearance between ground and footplate (Ground Clearance).
2. When ready use Button 8 to save Ground Touch. Led 8 - solid green while holding sw8, position is saved
or
When ready use Button 7 to save Ground Clearance Led 6 - solid green while holding sw7, position saved
3. Restart system (Off and On)!



6. Enabling/Disabling stand and drive (Only Corpus VS)

By default, the seat system is set with the “Stand and Drive” option for Corpus VS.

To change to Stand NO drive the system needs to be started up with a combination of pressed Buttons Press and hold Button 1, 2 and 7 on the ICS Switchbox, while holding these buttons, turn on the wheelchair with the Power Button on the Joystick (or other Input Device).

Once all LEDs on the ICS Switchbox turn green, release Buttons 1, 2 and 7.

- LED #7 flashes RED and LED #8 flashes GREEN to signify Selection mode.

The status is represented with LEDs 1, 2 on the ICS Switchbox. Ignore LEDs 3-6 when adjusting this setting.

Press Button 1 or Button 5 to change the status and press and hold Button 8 for two seconds to save the setting. Turn the wheelchair off and back on to continue normal usage

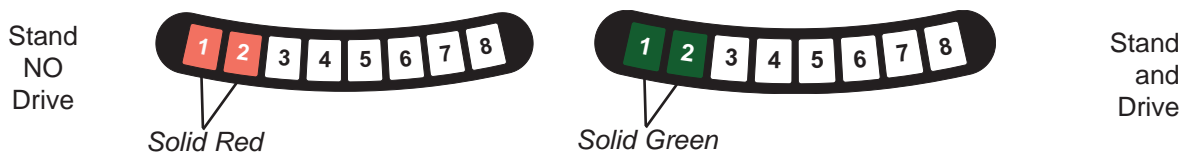

VS - Specific Attributes

NOTE! Do NOT apply for Corpus VS

Choosing a Standing Sequence

The ICS System allows the standing sequence to be selected from one of three pre-defined sequences. The standing sequence is chosen to best suit the user's needs. The system always requires a seat height adjustment when changing from one sequence to another, this is a safety precaution.

To successfully program the Standing Sequence or Sequences, the seven steps below MUST be completed properly.

1. Enter the Standing Sequence Selection mode using the ICS Switchbox:

- Turn off the wheelchair.
- Press and hold Button 5 and Button 7 on the ICS Switchbox
- While holding these buttons turn on the wheelchair with the Power Button on the Joystick (or Input Device).
- Once all LEDs on the ICS Switchbox turn green, release Buttons 5 and 7.

LED #8 will toggle between GREEN and RED to signify Standing Sequence Select mode.

IF LED #8 does not toggle GREEN/RED, the system is not in the programming mode, begin again.

2. Choose the desired standing sequence:

- Look at the descriptions of the Pre-Defined Standing Sequences shown on the following pages.
 - Select one or two sequence(s) that is/are appropriate for the end-user.
 - Determine which button needs to be activated to select this sequence using the switchbox.
- If you wish to use Pre-Defined Sequence 1, button 1 or 5 will be used in the next step.
 - If you wish to use Pre-Defined Sequence 2, button 2 or 6 will be used in the next step.
 - If you wish to use Pre-Defined Sequence 3, button 3 or 7 will be used in the next step.

3. Begin programming the desired sequence:

When using Switchbox Layout 1 (sticker D), Layout 2 (sticker E) or Layout 3 (sticker F):

- a) Press and hold Button #1, #2 or #3 to select the desired pre-defined sequence.
 - b) The left part of the symbol above the button will glow green.
 - c) Release the button after the left part of the symbol turns red.
- LEDs 1 and 3 will glow green once a standing sequence has been selected.

When using Switchbox Layout 4 (sticker G), two different standing sequences can be stored:

To store the selected sequence in the “Left” Stand Icon:

- a) Press and hold Button #1, #2 or #3 to select the desired pre-defined sequence.
 - b) The left part of the symbol above the button will glow green.
 - c) Release the button after the symbol turns red.
- LEDs 1 and 3 will glow green once a standing sequence has been selected for the “Left” Stand Icon.

To store the selected sequence in the “Right” Stand Icon:

- d) Press and hold Button #5, #6 or #7 to select the desired pre-defined sequence.
 - e) The right part of the symbol above the button will glow green.
 - f) Release the button after the symbol turns red.
- LEDs 2 and 3 will glow green once a standing sequence has been selected for the “Right” Stand Icon.

4. Operate the standing sequence and adjust the footplate clearance:

- a) Press Button #1 to begin standing the seat.
- b) Watch the footplate wheels as the seat is stood, raise the Seat Elevator using Button #2 to prevent the footplate wheels from colliding with the ground.
- c) Continue to use Button #1 to stand the seat until the Stand Angle is at the desired position.
- d) Adjust the height of the Seat Elevator for proper footplate wheel clearance, using Button #2 and #6.

Proper Footplate Wheel Clearance:

- If the user is in the wheelchair, the Footplate Wheels must touch the ground.
- If the wheelchair is empty, there should be 10mm between the Footplate Wheels and the ground.

5. Store the final stand position and settings:

- a) Press and Hold Button #8 for two seconds.
- b) Release the button after a short beep sounds and LEDs #7, #8 turn green.
- c) If LED #7 does not turn green, the store was not successful. The elevator is too high, lower it and try again.

In this step, the selected Standing Sequence, desired Final Standing Angle and proper Footplate Clearance are permanently stored by the system. This information will be used when the appropriate Stand Button is activated and the seating system will stop at this final position.

6. Test the settings for proper operation:

- a) After the standing information has been stored, turn the chair off and back on again.
- b) Test the Standing Sequence using the appropriate switches or the joystick)
- c) Confirm that everything works as expected.
- d) Make sure that the footplate wheels have the appropriate clearance when the chair is completely stood.

If changes need to be made, restart the Standing Sequence Selection mode by starting at Step 1.

7. If Layout 4 is being used:

- a) Begin from Step 1 and program the desired sequence for the other Stand Icon.

Since Layout 4 (Sticker G) is able to access two standing sequences, both standing sequences must be programmed before the seating system can be utilized.

Pre-Defined Standing Sequences

Pre-Defined 1: "Sit to Stand"

This sequence is similar to the "tic-tac" stand found on the Combination Vertical Seat.

But, with "stepless" movement of the backrest, legrest and standing actuators.

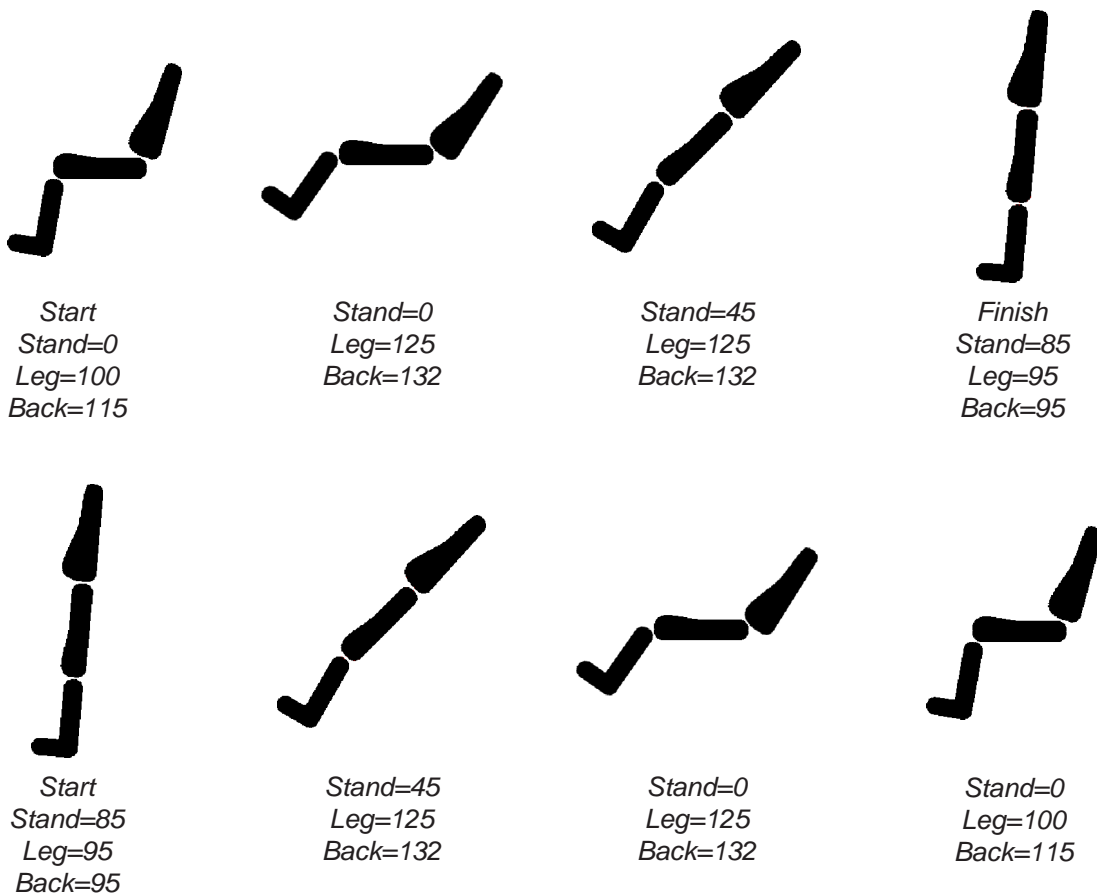

The "down" sequence finishes with the user in a nearly upright seated position.

Pre-Defined Standing Sequences

Pre-Defined 2: Tight "Sit to Stand"

This sequence is similar to the Default 1, except the backrest and legrest angles are more "contracted". This results in a faster transition to standing, where the backrest angle opens less while the seat pan angle increases.

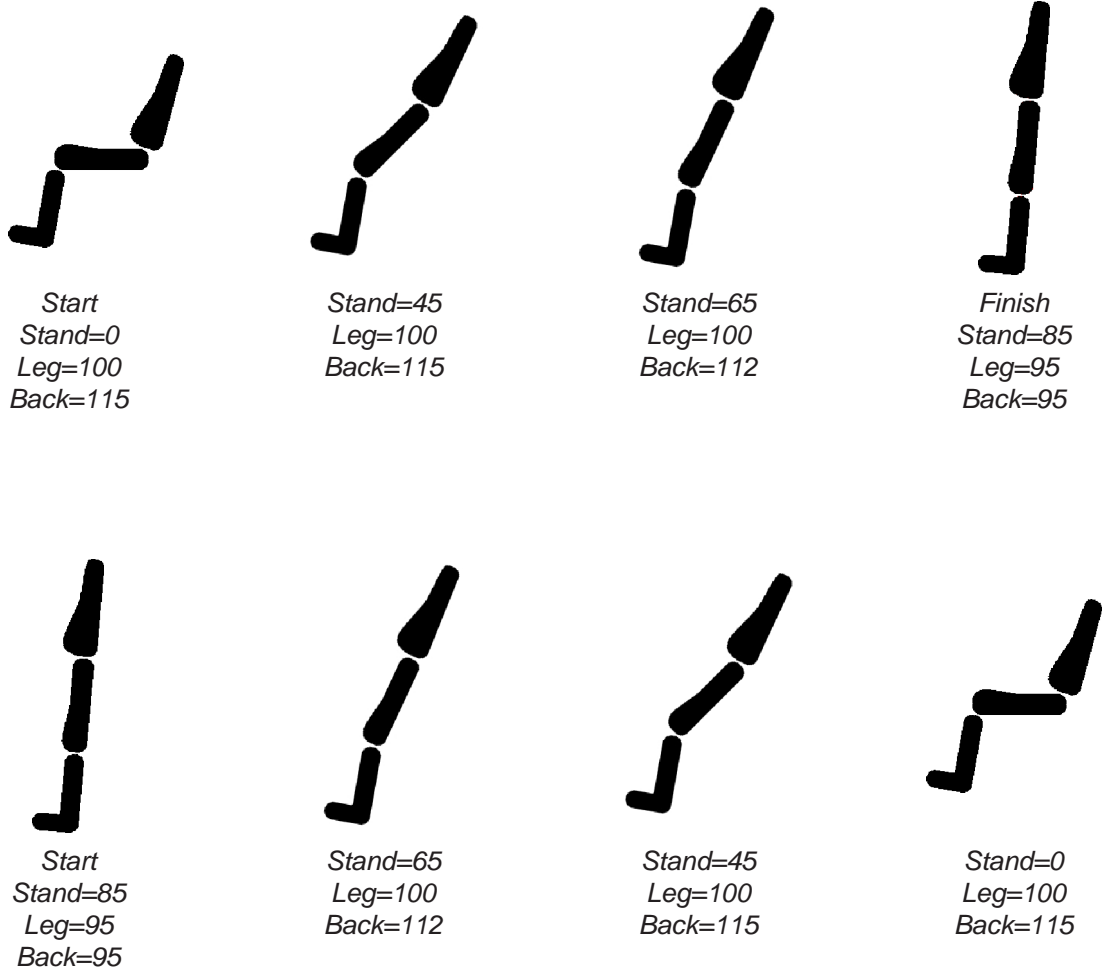

The "down" sequence finishes with the user in a nearly upright seated position.

Pre-Defined Standing Sequences

Pre-Defined 3: "Lay to Stand"

This sequence is similar to a "Tilt Table" Stander.

First, the backrest and legrest are moved to 180°. Then the seat pan angle is transitioned to the vertical position, much like a tilt board.

Pre-Defined 3 Standing Sequence - UP Overview

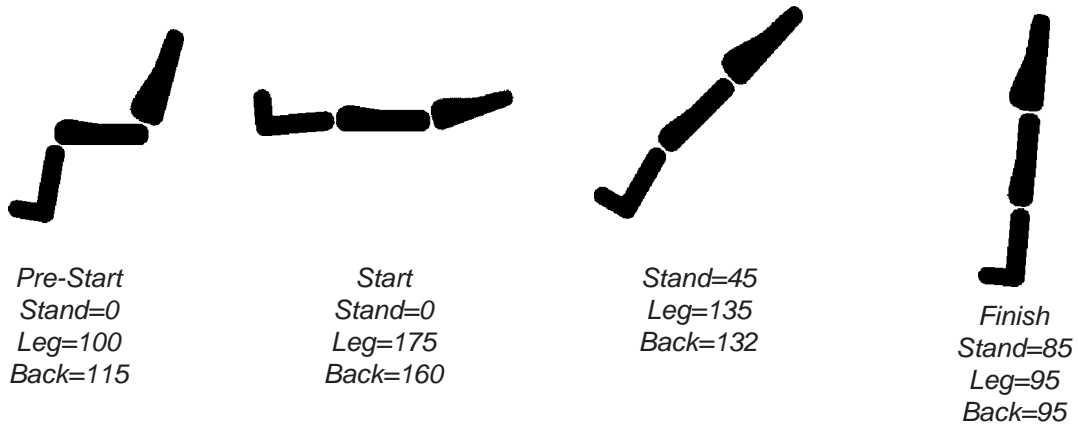

The "up" sequence starts by placing the user in a supine position.

Pre-Defined 3 Standing Sequence - DOWN Overview

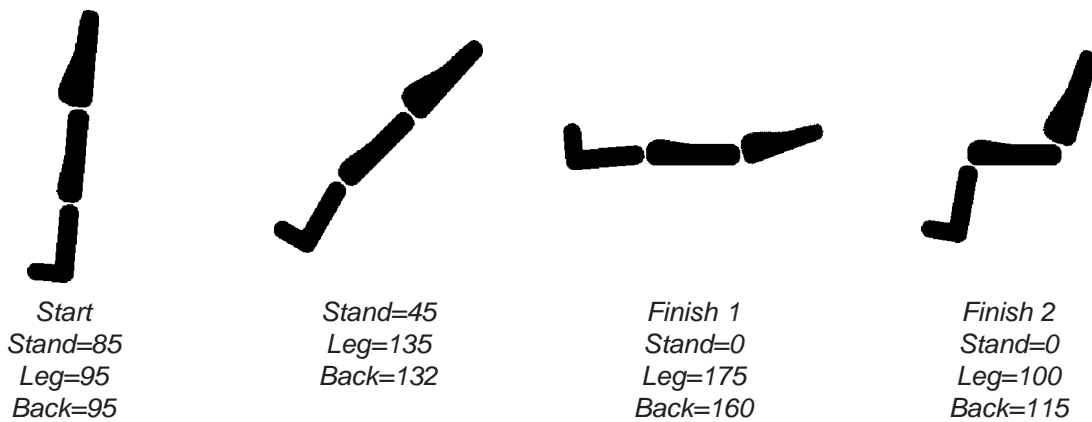

The "down" sequence finishes with the user in a supine position, but then transitions the user to an upright seated position.

NOTE: If the user wishes to remain in a supine position after 'un-standing', they should STOP activating the joystick or switchbox button when they have reached the lying position.

The final "down" position of this sequence can transition the user to a seated position after the supine position by using WheelChair Builder.

Setting Legrest Type

The VS Seat has two styles of legrest available. In order for the wheelchair to operate correctly, the legrest type must be stored in the Intelligent Control System.

By default, the system is set with the “Stand NO Drive” legrest option.

To change the Legrest Type:

To enter the Legrest Selection mode, the system needs to be started up with a combination of pressed buttons: Press and hold Button 1, 2 and 7 on the ICS Switchbox, while holding these buttons, turn on the wheelchair with the Power Button on the Joystick (or Input Device).

Once all LEDs on the ICS Switchbox turn green, release Buttons 1, 2 and 7.

- LED #7 flashes RED and LED #8 flashes GREEN to signify Legrest Selection mode.

The Legrest type is represented with LEDs 1, 2 on the ICS Switchbox. Ignore LEDs 3-6 when adjusting this setting.

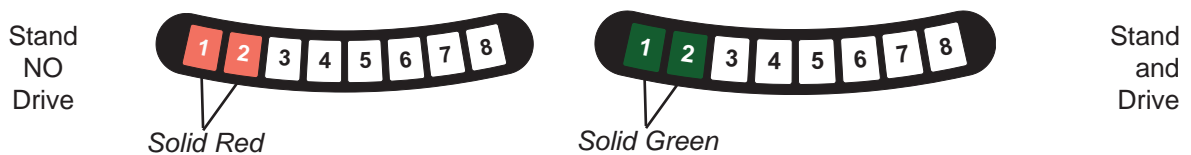

Press Button 1 or Button 5 to change the Legrest type.

After the appropriate Legrest type is displayed with the LEDs, press and hold Button 8 for two seconds to save the setting. Turn the wheelchair off and back on to continue normal usage.

Setting Optional Tilt

The VS Seat is available with an optional Power Tilt. When this powered seat function is fitted to the seating system, the Intelligent Control System must be programmed accordingly in order for the wheelchair to operate correctly.

The system is programmed correctly when it leaves the factory. Therefore, this setting only needs adjustment if Power Tilt is added or removed from the seating system, in the field.

To change the Tilt Setting:

To enter the Tilt Selection mode, the system needs to be started up with a combination of pressed buttons: Press and hold Button 1, 2 and 7 on the ICS Switchbox, while holding these buttons, turn on the wheelchair with the Power Button on the Joystick (or Input Device).

Once all LEDs on the ICS Switchbox turn green, release Buttons 1, 2 and 7.

- LED #7 flashes RED and LED #8 flashes GREEN to signify Tilt Selection mode.

The Tilt status is represented with LEDs 5, 6 on the ICS Switchbox. Ignore LEDs 1-4 when adjusting this setting.

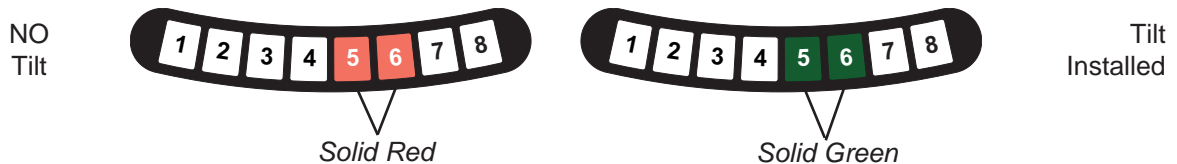

Press Button 3 or Button 7 to change the Tilt setting.

After the appropriate Tilt setting is displayed with the LEDs, press and hold Button 8 for two seconds to save the setting. Turn the wheelchair off and back on to continue normal usage.



K450 - Specific Attributes

Enabling Transport Position (WC19) Mode

The K450 can be equipped with an optional transportation kit. When the transportation kit is fitted, the ICS must be programmed accordingly in order for the wheelchair to operate correctly. If the Transport Position Mode is turned off, the user will not be able to place the K450 in the transportation position before entering a vehicle.

This setting is programmed correctly when the wheelchair leaves the factory. Therefore, this setting only needs adjustment when a Transportation Kit is added or removed in the field.

To change the Transport Position Enabled setting:

To enter the Transport Position Enabled selection mode, the system needs to be started up with a combination of pressed buttons: Press and hold Button 1, 2 and 7 on the ICS Switchbox, while holding these buttons, turn on the wheelchair with the Power Button on the Joystick (or Input Device).

Once all LEDs on the ICS Switchbox turn green, release Buttons 1, 2 and 7.

- LED #7 flashes RED and LED #8 flashes GREEN to signify Transport Position Enabled selection mode.

The setting is represented with LEDs 1, 2 on the ICS Switchbox. Ignore LEDs 3-6 when making this adjustment.

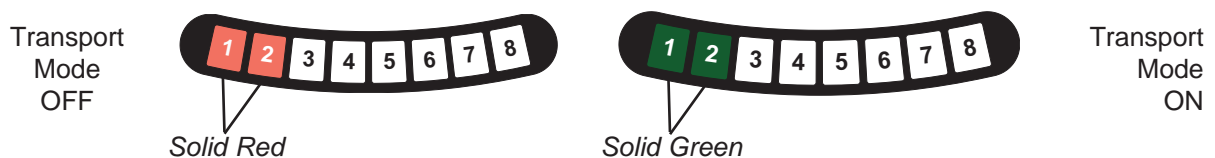

Press Button 1 or Button 5 to change the Transport Mode Enabled setting.

After the desired setting is displayed with the LEDs, press and hold Button 8 for two seconds to save the setting. Turn the wheelchair off and back on to continue normal usage.

Setting Optional Tilt

The K450 is available with an optional Power Tilt. When this powered seat function is fitted to the seating system, the ICS must be programmed accordingly in order for the wheelchair to operate correctly.

The system is programmed correctly when it leaves the factory. Therefore, this setting only needs adjustment if Power Tilt is added or removed from the seating system, in the field.

To change the Tilt Setting:

To enter the Tilt Selection mode, the system needs to be started up with a combination of pressed buttons: Press and hold Button 1, 2 and 7 on the ICS Switchbox, while holding these buttons, turn on the wheelchair with the Power Button on the Joystick (or Input Device).

Once all LEDs on the ICS Switchbox turn green, release Buttons 1, 2 and 7.

- LED #7 flashes RED and LED #8 flashes GREEN to signify Tilt Selection mode.

The Tilt status is represented with LEDs 5, 6 on the ICS Switchbox. Ignore LEDs 1-4 when adjusting this setting.

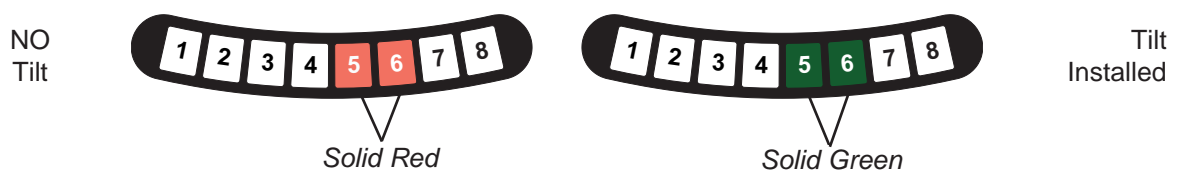

Press Button 3 or Button 7 to change the Tilt setting.

After the appropriate Tilt setting is displayed with the LEDs, press and hold Button 8 for two seconds to save the setting. Turn the wheelchair off and back on to continue normal usage.

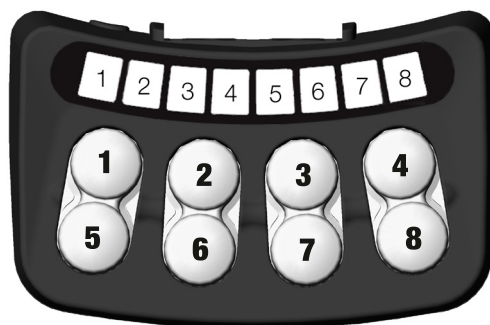

Setting Seat Width and Armrest Type

The MX seat pan on the K450 is available in four different widths:

250mm, 300mm, 350mm and 400mm or 10", 12", 14" and 16"

It is also possible to mount two different types of armrest on the MX seat:

Flip-up type, MX armrest or Removable type, PS Jr armrest

Since the MX seating system lowers between the front swing arms, the width of the seat pan and type of armrests that are mounted affect the free space between different areas of the seat and chassis.

In order to reduce the risk of injury to the user or damage to the wheelchair when wider seats are installed, it is possible to restrict how low to the ground the seating system can go.

How Seat Width & Armrest Type affect seat clearances:

	10" (250mm.) wide seat pan	12" (300mm.) wide seat pan	14" (350mm.) wide seat pan	16" (400mm.) wide seat pan
MX-arm	No Reduction	No Reduction	No Reduction	Reduction at seat rails and armrest "elbows"
PS Jr-arm	No Reduction	No Reduction	Small reduction at Armrest Receivers	Armrest Receivers will collide with swing arms.

Green
 Yellow
 Red

Use the ICS Switchbox to adjust the setting of how low to the ground the seat can move:

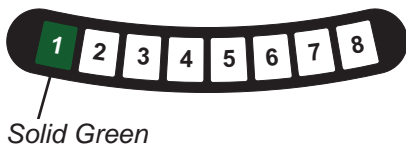

No Restriction, Seat Pan as low as 3.5".
Use for all Green combinations in table above.

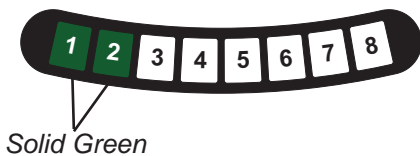

Some Restriction, Seat Pan no lower than 10"
Use for all Yellow combinations in table above.

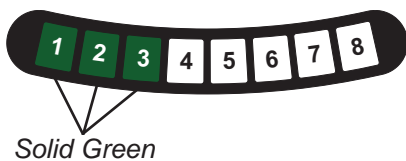

High Restriction, Seat Pan no lower than 16"
Use for all Red combinations in table above.

Changing the Seat Width Setting on K450:

1. Enter the Seat Width Selection mode:
 - a) With the wheelchair off, press and hold Buttons 3, 4 & 6 on the ICS Switchbox.
 - b) While holding these buttons, turn on the wheelchair with the Joystick (or Input Device).
 - c) When all LEDs on the ICS Switchbox turn green, continue to hold the buttons.
 - d) After approximately five seconds, the switchbox will emit a rapid beep and the LEDs will change. Release Buttons 3, 4 & 6.
 - LED #7 will flash GREEN* and LED #8 will flash RED* to denote Seat Width Selection mode.

2. Select the desired Seat Width Setting:
 - a) Once in the Seat Width Selection mode, the current setting will be displayed.
 - b) Select the desired value using Button 1 and 5 on the switchbox.
 - Button 1 will increase the setting and Button 5 will decrease the setting.

3. Save the desired setting:
 - a) When the desired setting is displayed, press and hold Button 8 for two seconds to save.
 - b) Turn off the wheelchair to exit the Seat Width Selection mode.
 - c) Turn the wheelchair on and confirm the seat operates as desired. If not, repeat the process.

* The following applies for config. files prior to October 15, 2010. LED 7 flashes red and LED 8 flashes green to indicate seat width selection mode.



Performing Automatic Actuator Calibration on K450

Due to the unique position the K450's seat positioning mechanism must be in to provide access to the actuator fasteners, when a new actuator is being installed the actuator ram must be manually extended, by rotating it by hand, to match the seat's position. This effectively "breaks" the calibrated position between the actuator's position sensor and the actuator's actual length.

However, each actuator fitted to the K450 contains a special type of position sensor that will re-align its position information when the actuator is allowed to run from one physical end stop to the other. Since the ICS controller does not normally allow each actuator to make a "hard stop" at each physical end stop, it is necessary to enter a special mode that will allow this movement.

Therefore, when one or more of the actuators on the K450 are replaced, it is necessary to perform an actuator calibration so that the actuator position sensors will communicate the correct positions to the ICS seating control system.

There are two ways to perform the calibration, the automatic mode is suggested and preferred.

Using Automatic Calibration:

1. Press and hold buttons 6 and 8 on the ICS Switchbox while turning on the wheelchair.
2. Once all the LEDs on the ICS Switchbox show in a green toggling pattern, release the buttons.
3. Begin the automatic calibration by activating button 8 on the ICS Switchbox.
4. Once button 8 is activated, the ICS will move the seating system in a specific sequence to make all the actuators reach both ends of travel – completing the calibration.

The automatic movement sequence consists of five "steps":

- a) Tilt actuator moves fully in (completely un-tilted.) Once the ICS confirms the tilt actuator sensor gives a fully in reading, Switchbox LED 1 turns green.
 - b) Then, all actuators will move to their fully out positions (Full Tilt, Full Elevator, Terra fully away from floor.) Once the ICS confirms these positions, Switchbox LED 2 turns green.
 - c) Once all actuators have reached their fully out positions, the Tilt actuator is moved inwards and the Terra moves down. After the Tilt sensor shows the tilt is less than 10°, Switchbox LED 3 turns green.
 - d) The Terra actuator continues to move down (towards the floor.) Once it is fully down, the ICS confirms its lowest position and Switchbox LED 4 turns green.
 - e) Then, the Terra actuator will move up and the Seat Elevator will move to its lowest position. Once the Seat Elevator is at its lowest position, the R-net Joystick will give a "calibration passed beep" (beep-beep-beep-beep-beeeeeeeep) to confirm that calibration has been completed successfully. All of the LEDs on the ICS Switchbox will flash green also.
5. Once the calibration passed beep is heard, turn the chair off then back on. The ICS switchbox will show a red toggling flash (asking for a system restart), turn the chair off again. When the chair is turned on, normal functionality is restored.

It is critical that the seating system is closely monitored during the automatic calibration.

If any strange noises (actuators binding) are heard during the automatic calibration, TURN OFF the wheelchair immediately. Also, visually confirm that the actuators are moving to both ends of travel during the calibration sequence. If an actuator “stops in the middle” during automatic calibration, there may be a problem with that actuator or sensor (try performing a manual calibration to attempt to resolve the problem.)

Errors during Automatic Calibration

The Automatic Calibration sequence performs several checks to confirm that each of the five calibration steps have been successful. If the ICS detects that a step was not completed successfully, it will give notification of this failure by sounding the R-net joystick’s horn continuously. Note how many LEDs are illuminated on the switchbox and the position of the seating system before turning off the chair to silence the notification (and exit the calibration mode.) Try automatic calibration a second time, if the failure occurs again, attempt a manual calibration (explained on the next page.)

Performing Manual Actuator Calibration

1. Begin in the seating system in a “normal driving” position (not tilted, not elevated, not at floor.)
2. Press and hold buttons 6 and 8 on the ICS Switchbox while turning on the wheelchair.
3. Once all the LEDs on the ICS Switchbox show in a green toggling pattern, release the buttons.
4. Press button 6 to move the elevator fully down. Don’t release the button until the actuator makes a “hard stop” at the lowest seat elevator position.
5. Press button 2 to move the elevator fully up. Again, don’t release the button until the actuator makes a “hard stop” at the highest seat elevator position.
6. Press button 5 to move the Tilt actuator to its fully un-tilted position. Don’t release the button until the actuator makes a “hard stop” at the lowest seat elevator position.
7. Press button 1 to move the Tilt actuator to its fully tilted position. Again, don’t release the button until the actuator makes a “hard stop” at the highest seat elevator position.
8. Press button 5 to move the Tilt actuator to its middle position (less than 30° tilt). Leave the tilt at this position for the remainder of the manual calibration process.
9. Press button 3 to move the Terra actuator to its fully extended position (away from the floor.) Don’t release the button until the actuator makes a “hard stop” at the fully extended position.
10. Press button 7 to move the Terra actuator to its lowest position (towards the floor.) Again, don’t release the button until the actuator makes a “hard stop” at the at the lowest position.
11. Turn the chair off to save the calibration information and to exit the calibration mode. Turn the chair back on to restore normal functionality.
12. Test the functionality of all of the actuators one at a time

After Manual Calibration is completed, confirm that the LEDs on the switchbox appropriately indicate the correct drive restrictions when the seat is at different heights.

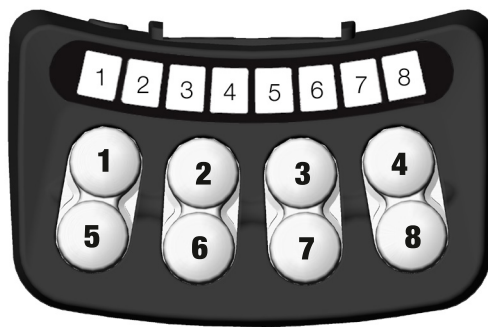

Transportation (WC19) Mode Hook Position

The Transportation Mode (WC19 mode) moves the seat positioning mechanism to a location that docks the seating system with the chassis using hooks that extend from the rear of the seat frame. If the seating system is NOT fitted with Power Tilt, the position the seat hooks move to when the Transportation Mode is assumed needs to be adjusted. Also, because of manufacturing variations, it is sometimes necessary for the hooks on a seating system with Power Tilt to be adjusted.

To determine if the position of the hooks needs adjustment, put the wheelchair into the Transportation Mode and slowly move the seating system to the dock position using brief presses of Button 5. While moving the seat to the dock position, check the alignment of the hooks with the loops on the chassis. If the hooks are not centered around the chassis loops when the seat elevator reaches its fully position, the position of the hooks needs to be adjusted.

Adjusting Hook Position on K450:

1. Enter the Transportation Hook Adjustment mode:
 - a) With wheelchair off, press and hold Buttons 6 & 8 on the ICS Switchbox.
 - b) While holding these buttons, turn on the wheelchair with the Joystick (or Input Device).
 - c) Once the ICS Switchbox LEDs show in a green toggling pattern, release the buttons.
 - d) Next, press and hold Button 4 for approximately five seconds, the LEDs on the switchbox will change and the seating system will start to move. Release Button 4.
 2. The switchbox buttons will now control the seating system in a special manner:
 - a) Buttons 1/5 will move the seat elevator up/down.
 - b) Buttons 2/6 will move the hooks backward/forward in relation to the chassis loops.
 - c) Buttons 3/7 will move the hooks up/down in relation to the chassis loops.
 - d) Button 4 will operate the Transportation Mode sequence.
 - e) Button 8 will save the current position of the hooks – this is the position the seating system will move to when the transportation position is reached.
 3. Fine-Tune the position of the hooks:
 - a) Use Button 4 to move the hooks near the chassis loops.
 - b) Once the hooks are near, release Button 4.
 - c) Use Buttons 2/6 and 3/7 to fine-tune the hook position in relation to the chassis loops. A properly positioned hook will be centered around the loop and apply slight pressure on the loop when the seat elevator is as low as possible.
- NOTE:** When adjusting the hook position, avoid moving the hooks to a position where they press too hard on the chassis or chassis loops. If this occurs, immediately stop pressing Buttons 2/6 or 3/7 and use Button 1 to raise the elevator and reduce the hook pressure.
- d) While adjusting the hooks, it is possible to save your progress using Button 8.
 - e) Once the hooks are in a satisfactory position, store the final position using Button 8.
 - f) Turn the wheelchair off and back on to return to the normal operating mode.
 - g) Check the operation of the Transportation Mode and confirm proper positioning of the hook. If the hooks do not correctly align with the chassis loops, begin from Step 1 again.

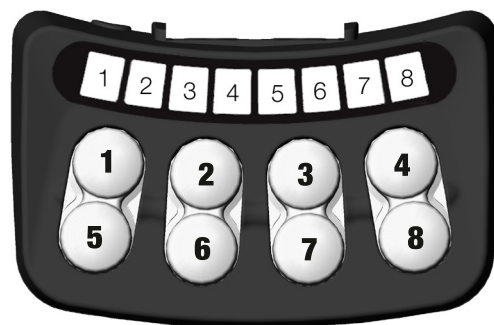

Configuring ICS through R-net control panel

Additional ICS configuration is possible using R-net's OBP function. To enable OBP, a programming key (R-net dongle) must be connected to the R-net system.

NB! OBP cannot be used with the R-net LED Joystick Module.

The following functions/adjustments can be configured in this way:

- Changing the seat function order in Seating Mode
- Limiting permitted seat function movements
- Adjusting when a seat position will reduce the chair's speed
- Adding or removing seat functions when the seat's physical configuration is changed (actuator added or disconnected)
- Configuring functions for Alternative Switchbox

Enabling the ICS menu in OBP

To enable OBP, a programming key (PGDT R-net dongle) must be connected to the R-net system. Follow the sequence below:

1. Switch off the system
2. Connect the dongle to the R-net system
3. Switch on the system
4. After start-up press the Mode button until the OBP menu appears on the LCD display
5. Select the ICS menu

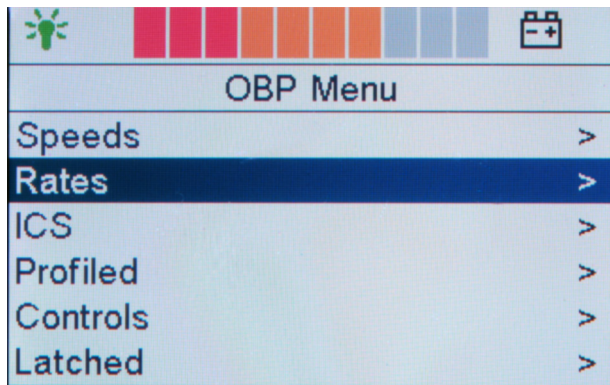

Changing the seat function order in Seating Mode

It is possible to specify the order in which the icons for the various seat functions appear on the LCD display when scrolling using the joystick in Seating Mode. See also the section entitled “Basic seat operation...” on page 15.

You can choose any order for the available seat functions. This is done using the Seat Icon Dsp Ord 1 and Seat Icon Dsp Ord 2 menus.

Specify a preferred number for each existing seat function.

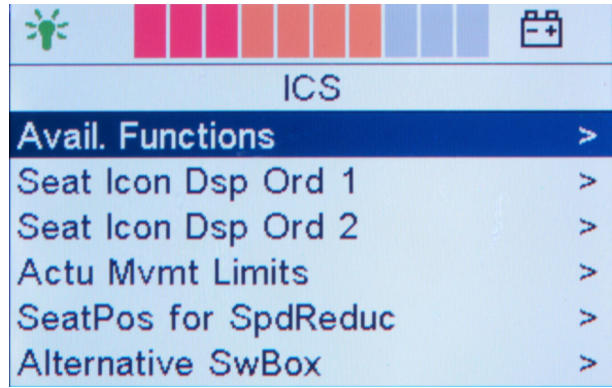

Seat Icon Dsp Ord 1 includes the most common seat functions: seat elevator, tilt, recline, legrest and the memory functions.

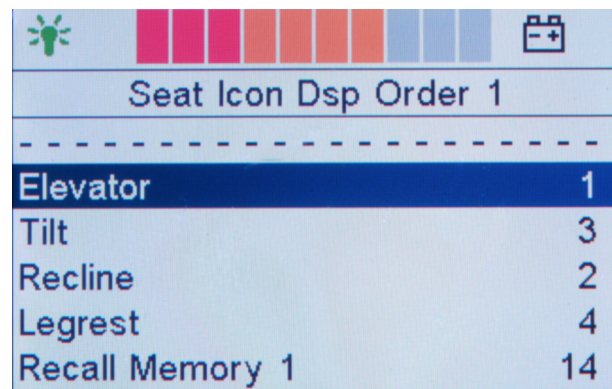

Seat Icon Dsp Ord 2 includes any other seat functions, such as the standing function for a VS seat and extra functions/adjustments.



When the chair has been switched off, the seat function numbered 1 will be shown when Seating Mode is activated. Otherwise, it will be the last function used.

Limiting the seat's permitted movements

As standard the seat's maximum movements are based on the actuator's stroke length and the stability of the chair at different configurations, as well as the user's weight. If you still need to limit the seat's maximum movements, this can be done using the **Actu Mvmt Limits** menu.

NB! Only works if the seat function has position feedback.

The values for the tilt angles Min/Max Tilt Angle are indicated in degrees to the horizontal plane.

The values for Min/Max Back Angle and Min/Max Leg Angle are indicated in degrees to the seat.

The values for Max Elev Travel and Min Elev Travel for the range of movement of the seat elevator are indicated as vertical motion in millimeters (mm) from lowered position. Please note that this only works on seat elevators with a position sensor.

Actu Mvmt Limits	
Min Tilt Angle	-5
Max Tilt Angle	45
Min Back Angle	80
Max Back Angle	175
Min Leg Angle	80

Adjusting the seat position for speed reduction

As standard the chair's speed is limited by the position of the seat and the chair's stability at different configurations, as well as the user's weight. If you would like to increase the restrictions, you can do this using the **SeatPos for SpdReduc** menu.

The values for the tilt angle *Tilt Low Spd Angle* at which speed is limited and *Tilt Drv Inhib Angle* at which driving is blocked are indicated in degrees to the horizontal plane.

The values for the backrest angle *Back Low Spd Angle* at which speed is limited and *Back Drv Inhib Angle* at which driving is blocked are indicated in degrees to the horizontal plane.

The values for the legrest angle *Leg Low Spd Angle* at which speed is limited and *Leg Drv Inhib Angle* at which driving is blocked are indicated in degrees to the seat.

The values for the seat elevator position *Elev Low Spd* at which speed is limited and *Elev Drv Inhib* at which driving is blocked are indicated as vertical motion in millimeters (mm) from lowered position. Please note that this only works on seat elevators with a position sensor.

SeatPos for SpdReduc	
Tilt Low Spd Ang	60
Tilt Drv Inh Ang	10
Back Low Spd Ang	180
Back Drv Inh Ang	180
Leg Low Spd Ang	80

Adding or removing seat functions

When you subsequently add a seat function, e.g. tilt, or make an adjustment to a chair or if you remove a function, you may need to configure the ICS system in order to ensure full operation. By making corrections in the **Avail. Functions** menu and specifying the type of seat function installed, the system is usually able to function without any additional re-programming.

Some connected functions will be configured automatically (Plug and play) and do not require any changes to be made to the Avail. Functions menu. This is the case, for example, when a function using a Smart actuator (IQ actuator) is connected.

The various types for each function correspond to a certain version of the seat elevator, tilt, etc. Examples are shown in a table below. For some functions it is possible to install a manual alternative without an actuator but with position feedback. Select "Manual" in the menu for this function.

The various seat function types are shown in tables on pages 66-69.

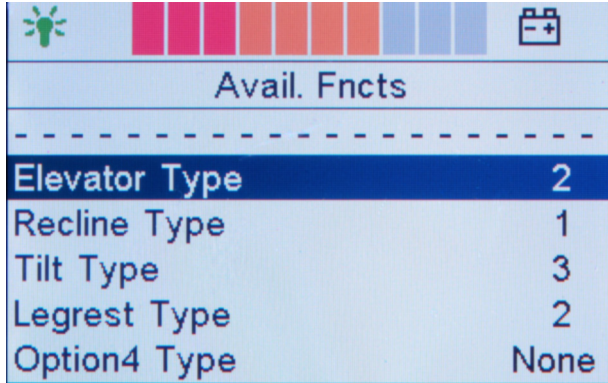

Avail. Fncts	
Elevator Type	2
Recline Type	1
Tilt Type	3
Legrest Type	2
Option4 Type	None

Configuring functions for Alternative Switchbox

It is possible to connect up to 8 buttons to the Alternative Switchbox for control of the chair's seat functions. This works in parallel with control of the seat functions through normal switchboxes and via the joystick in Seating Mode.

Use the **Alternative SwBox** menu to define the function for each button.



The following seat functions can be selected for each button:

OBP Text	Function	Description
0	OFF	No function
1	Elevator	Seat elevation
2	Tilt	Seat angle
3	Recline	Backrest
4	Legs	Legrest
5	Recall Mem Pos 1	Return to memory position 1
6	Recall Mem Pos 2	Return to memory position 2
7	Recall Mem Pos 3	Return to memory position 3
8	Set Mem Pos 1	Save memory position 1
9	Set Mem Pos 2	Save memory position 2
10	Set Mem Pos 3	Save memory position 3
11	Axis 11	Standing function A or Extra function
12	Axis 12	Standing function A or Extra function
13	Axis 13	Extra function
14	Axis 14	Extra function
15	Axis 15	Extra function
16	Axis 16	Extra function

The following button functions can be selected for each button:

OBP Text	Description
Togl	Toggle
Up	Upwards
Down	Down

Configuring ICS through R-net PC programmer

It is possible to achieve the same ICS settings with the R-net PC programmer (Dealer) as with R-net OBP. See the section entitled “Configuring ICS through R-net control panel”.

The same parameters are available as with OBP. These can be found in the menus under Seating > ICS in the PC programmer for R-net. See the screenshot below.

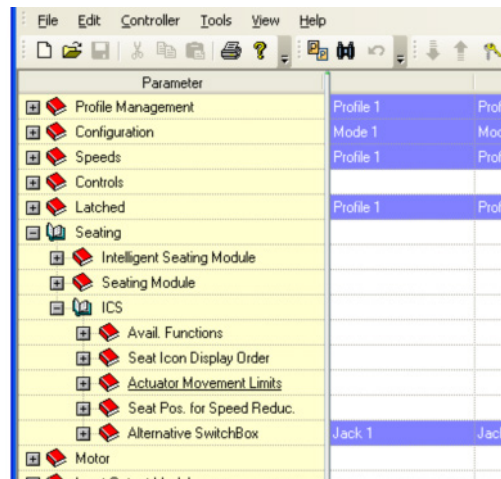







Chapter 3 – Diagnostics & Troubleshooting

Diagnostic LED Indications

In addition to the LED indications the ICS Switchbox provides the user, there are several “diagnostic level” LED indications that are useful to a technician when troubleshooting the seating functions on a wheelchair with ICS.

Overview of the “user level” indications:

	Seat Function not available.		
	Function available Full Drive Speed allowed		Function available Drive Speed limited by this function
	Memory Mode		Memory Mode
			Function available Drive Inhibited by this function
			End-of-Travel reached Current Limit reached

“Diagnostic Level” indications:



The Brief Red Flash indication is a red flash that occurs for 5 seconds, then the switchbox returns to its previous indication state.

This is the same indication the user gets when an actuator end-of-travel is reached. It also serves as a Diagnostic indication if the brief red flash is occurring when the actuator is NOT at the end of travel (maybe the seat function is binding, or maybe the actuator needs to be replaced due to wear.)

The Brief Red Flash also occurs when there is a problem with the actuator sensor. If the actuator is using a softpot, this could indicate the softpot or softpot cable is worn and needs to be replaced.



The Constant Red Flash always occurs, it never stops.

When an icon on the Switchbox gives a constant red flash this signifies that the seating system expects that actuator to be connected, but is unable to communicate with it.

This could be caused by a bus communication wire between the actuator and the hub/master module being damaged.

This can also be caused by incorrect programming (ie. “Recline Installed”, but not connected.)

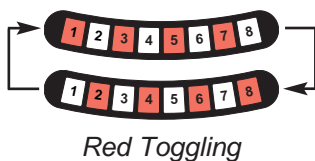

When the Switchbox LEDs toggle red, the ICS system is requesting that the wheelchair be turned off and back on. This display is given after a new device is connected to the system (plug-n-play) and after certain programming steps are completed.

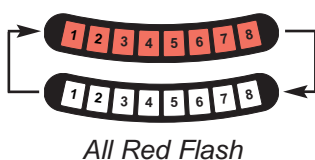

When ALL of the Switchbox LEDs flash red (all on, then all off), the ICS system is giving a notification that there is a Switchbox Layout setting error. This is a rare error, but if it occurs (using Wheelchair Builder) choose another Layout Number for the switchbox that is flashing and write the ICS settings again.

Seat Elevator Soft Pot Error Mode

The Seat Elevator fitted on the VS seating system is equipped with a Soft Pot positioning sensor. This Soft Pot sensor enables the ICS system to determine the exact height of the seat elevator. The height information is used to properly position the seat elevator during a standing sequence and enables storing and recalling of seat position memories. If the information received from the Seat Elevator Soft Pot sensor is incorrect, the seating system might be allowed to move to an unsafe position.

The ICS system routinely checks that it is receiving accurate information from the Soft Pot. If the system detects that incorrect information is being received from the Soft Pot, it will enter a limited operation mode to prevent the seating system from moving to an unsafe position. When the ICS system enters this limited operation mode, it provides notification to the user.

The system notifies the wheelchair user the Soft Pot Error Mode has been entered by flashing the Seat Elevator icon on the ICS Switchbox with a yellow/red flash:

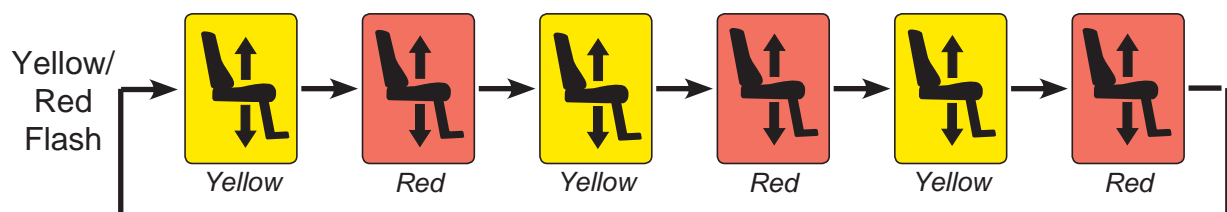

The system also notifies the wheelchair user the Soft Pot Error Mode has been entered by displaying a flashing M8 in the R-net Joystick when the joystick is in Seating Mode:

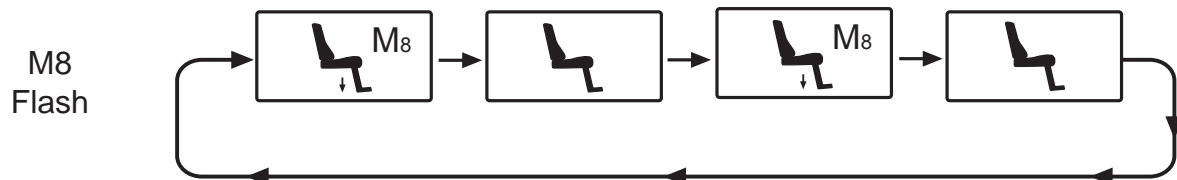

When the seating electronics are in the "Seat Elevator Soft Pot Error Mode", the functionality of the seating system and the driving system is limited in the following ways:

1. Stand Up is not allowed. Stand Down is allowed to enable the user to return to a seated position.
2. Elevator Up is not allowed. Elevator Down is allowed enabling the user to attempt to reset the error.
3. The Seat Elevator will move at a reduced speed.
4. The chair will only drive at a maximum of half-speed.

Note that once the Stand Actuator is fully un-stood the legrest, backrest and tilt will function normally.

The fault that caused the Elevator Soft Pot Error may have been temporary, therefore, the user may be able to reset the error mode by moving the seat elevator to its lowest position. Operate the seat elevator down button until elevator movement stops. If the system is receiving the correct information from the Soft Pot again, the Seat Elevator icon will return to a solid green color.

If the Seat Elevator is moved to its lowest position and the information from the soft pot is not correct, the yellow/red flashing and M8 flash will continue. The user should contact their Service Provider and notify them of the switchbox/joystick flashing so that a service technician can resolve the problem.

Once the Service Technician is with the wheelchair, the seating electronics can be placed in a special mode that will enable the technician to access the seat elevator for troubleshooting and repair.

Chapter 4 – Servicing

ICS Bus Connections

The Intelligent Control System has its own communication bus. All the devices used within the Intelligent Control System must connect to the ICS Bus in order to function.

To connect an ICS component to the system, an “open” ICS Port is required. ICS Ports can be found either in the ICS Master Module or in an ICS Connector Block.

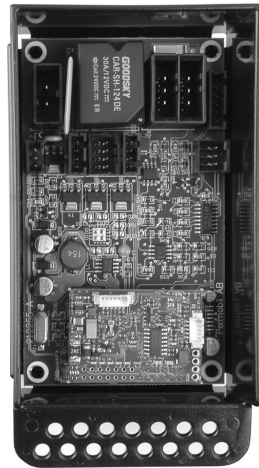
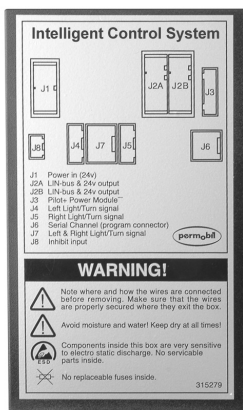

ICS Master Module with ICS Bus Connectors.



Connector Block

There are several locations on the wheelchair where ICS components can be connected, these locations will vary by seating system. ICS Connector Blocks are typically located in the backrest hinge area or seat pan area of a seating system. Refer to the appropriate Seating System Service Manual or Chassis Service Manual for more information on the location of ICS Connector Blocks.

There are always two ICS Bus Connections inside the ICS Master Module.

The ICS Master Module is located in the main chassis, near the Power Module.

The ICS System is designed so that any device can be connected to any “open” ICS Bus Port.

It is not necessary to connect actuators or switchboxes to specific ICS ports!

To connect a component to the ICS Bus, align the keying grooves in the male connector with the keying ridges in the female connector. Once aligned, press the male connector into the female connector until a **CLICK** is heard. The connectors can only be connected in one direction, do not force the connectors together!

To disconnect a component from the ICS Bus, depress the latching tabs on each side of the male connector and pull away from the female connector. The connectors positively latch together and the latching tabs must be depressed to enable removal. Do not pull on the cable when disconnecting an ICS Bus Connector, grasp the plastic housing instead!

APE-actuator Recalibration Mode

If the Linak LA28 actuator, item 324195, used in the Corpus APE and Corpus VS is replaced or detects a position fault the wheelchair will enter a recalibration mode where the Linak actuator moves into calibration position in an effort to recalibrate the sensor. In this mode any button on the switchbox will move the Linak actuator down, recline and legrest can also be adjusted during this phase to ensure that that no mechanical interference will occur. When the Linak actuator has moved to mechanical end position it is calibrated and triggers a restart request. After restart the seat functions is working normally again.

During recalibration mode LED #1 on the ICS switchbox is flashing red/yellow and the buttons have the following functions

Any active button moves Linak actuator down

Button 5 will also lower the Linix actuator, (front actuator of APE)

Button 3 & 7 will also operate Backrest

Button 5 & 8 will also operate Legrest

Switchbox Replacement

Consult Seating System Service Manual.

Actuator Replacement

Consult Seating System Service Manual.

General Module Replacement

Consult Seating System Service Manual.

Smart actuator calibration

If a Smart actuator is not handled correctly prior to installation in the seating system (i.e. the actuator screw being moved manually), the actuator's position sensor and ram can become mismatched.

It is important that the screw end of a Smart actuator is held in place with delivery tape until just before it is attached with bolts to the mounting brackets on the seating system.

If, however, the Smart actuator's integral sensor and the actuator's actual length become mismatched, it is possible to calibrate the actuator automatically (preferred) and some also manually.

Manual calibration is performed by moving the seating system's Smart actuator to a known position. The "problem actuator" is now removed to enable manual adjustment of the ram position, ensuring a correct value for the actuator's actual length. Alternatively this can be done before the actuator is installed, if it is known that the actuator screw has been moved manually or if actuator stroke is unexpectedly reaching a hard endstop (flashing red on ICS Switchbox).

To select actuator calibration mode:

1. Switch off the wheelchair.
2. The system needs to be restarted by pressing and holding a combination of buttons: Press and hold buttons 5, 6 and 3 on the ICS Switchbox. While doing this, switch the wheelchair on using the power button on the joystick (or input device).

Once all the LEDs on the ICS Switchbox light up green, release buttons 5, 6 and 3.

- > LEDs 7 and 8 flash red to indicate actuator calibration mode.

If you want to perform a manual calibration by manually adjusting the length of the actuator, go to point 8 under "Manual Calibration" on page 59. For automatic calibration, follow the instructions from point 3 on page 57.



3. Automatic calibration (Corpus II & Corpus 3G)

NB! The actuator must not be removed from the seat during automatic calibration, as the end positions are detected when the actuator reaches a mechanical stop, causing the current to exceed the current limit. Automatic calibration cannot be performed on chairs with “old ICS programs” < v.30 (december 2010) or for functions where the actuator is equipped with SoftPot.

NB! The actuator movement must be appropriate for the function and must not be mechanically obstructed by any external object or addition.

NB! If the seat is equipped with manual backrest, this must be positioned in its most forward position (to make maximum stroke of the tilt possible).

NB! If the seat is equipped with a fixed seat post and no tilt, the leg rest actuator must be removed in one end when performing the calibration. The piston must be prevented from rotating in the end position, using for example a screwdriver through the fixing hole.

4. Press button 4 to activate automatic calibration. LEDs 7 and 8 will flash green.

5. For Corpus APE & Corpus VS go to #8

For Corpus II & Corpus 3G

Decide what needs to be calibrated using button 2, 3 or 4.

Button 2 activates calibration of Tilt.

Button 3 activates calibration of Tilt+Backrest.

Button 4 activates calibration of Tilt+Backrest+Legrest.

Calibration is only performed on functions with Smart Actuators.

6. If you press button 3 or 4, each actuator will be calibrated in turn. Once calibration is complete, the seat will return to a “normal” seat position, and all the LEDs flash green and there will be a short audible signal if calibration has been successful.

Corpus 3G with manually adjustable backrest: When the tests comes to the seat back, it's waiting (LED 7 is flashing yellow) for you to manually fold the back rest to the rearmost position. When the backrest is in its rearmost position, press button 7 and when LED 6 blinks, manually fold the back rest to the its forward position. After that, the automatic calibration continues.

If calibration is unsuccessful, the LED for the actuator in question flashes red.

7. Restart the chair. Run a seat test.

Automatic calibration is now complete.

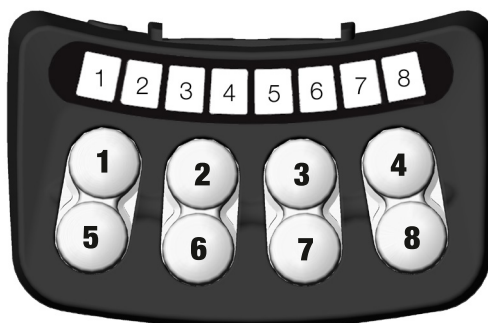

8. For Corpus APE & Corpus VS

Decide what needs to be calibrated using buttons 1 – 7 as in table below

Button on SB	Calibrate function	LED indication
1	Anterior tilt actuator	LED #1
2	Tilt (seat elevator actuator)	LED #3
3	Backrest actuator	LED #5
4	Full Auto calibration (all actuators)	LED #1- #6
5	Support wheels actuator (Corpus VS only)	LED #2
6	Articulation Legs actuator	LED #4
7	Legrest actuator	LED #6

LED #n is flashing green during calibration and solid green when ready.

Full Auto Calibration will calibrate all the possible actuators and during the calibration procedure move seat functions in a safe position avoiding collisions.

After completing a successful calibration, the system will issue a "calibration complete-beep" (beep-beep-beep-beep-beeeeeep) to confirm that the calibration is completed. All the LEDs on the ICS control panel will be flashing green.

9. Verify the seat functions manually.
10. Manual calibration (Not for Corpus 3G, Corpus APE and Corpus VS): Continue from point 2.
11. Switch off the wheelchair.
12. Remove the actuator that is not calibrated from the seating system.
13. Measure the distance between the center of the "front hole" and the center of the "fixed hole". Compare the length of the actuator with the values on the next page. Screw the actuator ram in or out to obtain the value in the table.
14. Check that the hole through the end of the actuator screw/ram is aligned with the fixed hole at the other end of the actuator (correct position is listed in the table).
15. Re-attach the actuator to the mounting brackets on the seating system.

Repeat steps 9-15 for any Smart actuator having a similar problem.

NB! Actuators with SoftPot sensors require a different calibration method.

SoftPot is a mechanical sensor that has no need of this re-calibration method. Although actuators with SoftPot sensors are moved to a known position during this process, it is not possible to adjust the screw end of the actuator manually to correct calibration. See the section entitled "Actuator calibration with SoftPot" for information on calibrating these particular actuators.



Calibration Lengths for Smart Actuators

VS Seating System

Actuator	Center-to-Center Length	Front Hole Position
Standing	520 mm	Aligned with "fixed" hole
Recline	250 mm	Aligned with "fixed" hole
Legrest	300 mm	Aligned with "fixed" hole
Tilt	300 mm	Aligned with "fixed" hole

RS Seating System

Actuator	Center-to-Center Length	Front Hole Position
Recline	300 mm	Aligned with "fixed" hole
Legrest	300 mm	Aligned with "fixed" hole

Corpus Seating System on C300 & C350

Actuator	Center-to-Center Length	Front Hole Position
Legrest	300 mm	Aligned with "fixed" hole

Corpus Seating System on C400 & C500

Actuator	Center-to-Center Length	Front Hole Position
Backrest	250 mm	Aligned with "fixed" hole
Legrest	300 mm	Aligned with "fixed" hole
Tilt 20°	Automatic calibration only	

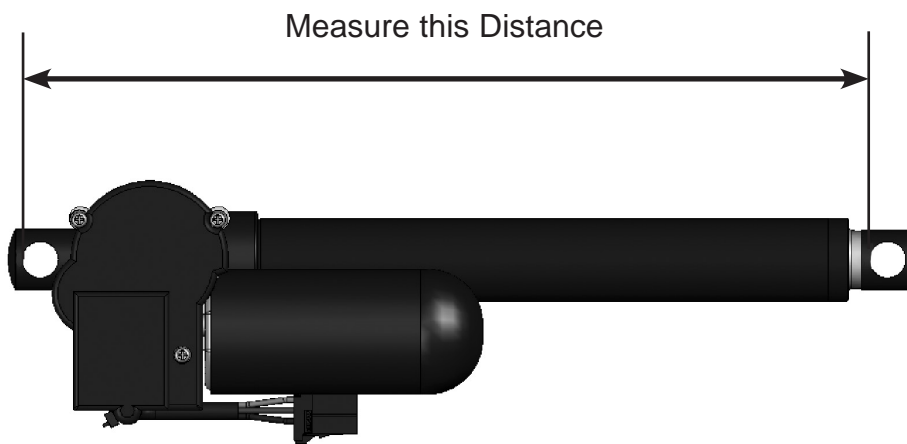

Actuator Calibration with Softpot

Actuators with SoftPot sensors are not affected by the Actuator Screw being manually moved like Smart Actuators are. It is possible, however, that the SoftPot housing on the actuator is inadvertently moved when the actuator is being installed.

If the SoftPot housing is not positioned in the correct location, the values that the SoftPot sensor provides to the ICS Master Module may not represent the actual length of the actuator screw. This can cause the seating system to recall memory positions incorrectly or move the actuator to an undesired position.

A mis-match between the actual length of the actuator and the length measured by the SoftPot can be corrected by moving the actuator to a known position and adjusting the position of the SoftPot housing on the actuator shaft.

The process begins by moving all of the actuators on the seating system to a “known” position. This part of the process is the same as for Smart Actuators.

To enter the Actuator Calibration mode:

1. Turn off the wheelchair.
2. The system needs to be started up with a combination of pressed buttons: Press and hold Button 5, 6 and 3 on the ICS Switchbox, while holding these buttons, turn on the wheelchair with the Power Button on the Joystick (or Input Device).

Once all LEDs on the ICS Switchbox turn green, release Buttons 5, 6 and 3.

- LED #7 and #8 will toggle RED to signify Actuator Calibration mode.

3. To move the Actuators to their calibration positions:

Press and hold Button 5 until LEDs 7 and 8 glow green.

For safety, releasing Button 5 will stop actuator movement. (Continue until LEDs 7 & 8 are Green.)

4. When LEDs 7 & 8 are Green, the sensors inside the actuators have reached a known position. (This enables the manual re-calibration.)
5. Turn off the wheelchair.
6. Remove the actuator that is out of calibration from the seating system.
7. Measure the distance between the center of the “Front Hole” and the center of the “Fixed Hole”. Compare the actuator’s length to the value in the chart on the next page.
8. Adjust the position of the SoftPot housing according to the following method:
 - If the measured value is less than the calibration length shown in the chart, the metal SoftPot housing must be moved away from the moving end of the actuator.
 - If the measured value is more than the calibration length shown in the chart, the metal SoftPot housing must be moved toward the moving end of the actuator.
9. Confirm that the hole through the end of the actuator screw/ram is aligned properly with the fixed hole at the actuator’s other end (the correct position is listed in the chart.)
10. Reattach the actuator to the mounting brackets on the seating system.

Repeat steps 6 – 10 for any other “problem” actuators with SoftPot sensors.



Calibration Lengths for Actuators with SoftPot Sensor

Corpus Seating System on C300 & C350

Actuator	Center-to-Center Length	Front Hole Position
30°/45° Tilt	400 mm	Aligned with "fixed" hole

Corpus Seating System on C400 & C500

Actuator	Center-to-Center Length	Front Hole Position
30° Tilt	300 mm	Aligned with "fixed" hole
45° Tilt	Automatic calibration only. See page 32.	

Emergency Manual Operation Mode (Take Me Down)

If the Position Sensor for the Standing Actuator fails, it is possible that the Seating System may be stuck in the standing position. Using the Emergency Manual Operation Mode, it is possible to return the chair to a normal seated position, to allow limited use before a service technician can repair the wheelchair.

Another possibility is that a positioning sensor for an actuator fails, making it difficult to access the electronics in the chassis or seating system. If this occurs, it should still be possible to use the Emergency Operation Mode to move the seating actuators to place the seating system into a "serviceable" position so that a technician can repair, replace and/or reprogram the electronics.

Read instructions completely before starting!

To access the Manual Operation mode:

1. Turn off the wheelchair.
2. Press and hold Button #6 and Button #8 on the ICS Switchbox.
3. While holding these buttons, turn on the wheelchair with the Power Button on the Joystick (or Input Device).
All LEDs on the ICS Switchbox will glow Green, continue to hold Buttons 6 and 8.
4. When all the ICS Switchbox LEDs glow RED, release Buttons 6 and 8. (Approximately 30 seconds)
The Switchbox LEDs will oscillate Green to signify you are in Manual Operation mode.
If the Switchbox LEDs do not oscillate Green, you are not in the Manual Operation mode, begin again.

While in Manual Operation mode:

The actuators operate at reduced speed while in the Manual Operation mode because the position feedback information is not used to prevent collisions or pinching between the seating system and the chassis.

Therefore, **USE EXTREME CAUTION** while using the Manual Operation mode and keep an eye on all moving parts during travel to avoid damage to the seating system or wheelchair.

STAY CLEAR OF MOVING PARTS to avoid personal injury.

If any unusual noises are heard, **RELEASE THE BUTTON IMMEDIATELY.**

Operating Seat Functions Manually:

The seat functions that are assigned to the switchbox buttons are different from the programmed layout while in the Manual Operation mode. During Manual Operation mode, the actuator operating speeds are limited to 50% to make it easier to monitor the seating system's movement visually. The button functions are shown below:

Seat Elevator Operation:

Button #2 will raise the Legrest
Button #6 will lower the Legrest

Legrest Operation:

Button #4 will raise the Legrest
Button #8 will lower the Legrest

Recline Operation:

Button #3 will move the Backrest forward
Button #7 will move the Backrest backward

Stand Operation:

Button #1 will raise the Stand Actuator
Button #5 will lower the Stand Actuator

NOTE: In Manual Operation mode, the Standing Sequence is not performed. Therefore, if the seating system must be moved to a standing position, the Seat Elevator, Legrest and Backrest must be operated separately to prevent the Stand Actuator from causing damage to the seating system or chassis.

**To exit Manual Operation mode:**

1. Turn the wheelchair off.

Definition of seat function types

GM = ICS General Module

V-Smart-act = ICS Vari-Smart Actuator

Spec. Adapt. = Special Adaptation

Seat Elevator

	Type 1	Type 2	Type 3	Type 4		Type None
C300/C350 Corpus II	Std, switch	Std, softpot or pillar	-	-	Fixed Tube	-
C400/500 Corpus II	Std, switch	Std, softpot or pillar	-	-	Fixed Tube	-
Street Cor- pus II	Pillar		-	-	Fixed Tube	-
C400/500 VS	Pillar	Pillar, no pinchprotect.		-	Fixed Tube	-
K300 PS Jr	Std, switch	Std, softpot or pillar	-	-	Fixed Tube	-
K450 MX	Std	-	-	-	-	-
Corpus 3G	Std, switch	Std, softpot or pillar	-	-	Fixed Tube	-
Corpus APE	Std (Linix)	-			-	-
Corpus VS	Std (Linix)	-	-	-	-	-

Tilt

	Type 1	Type 2	Type 3	Type 4	Type Man	Type None
C300/C350 Corpus II	30°	45°	-	-	Manual tilt	No tilt
C400/500 Corpus II	30°	45°	20°/LowRider	-	Manual tilt	No tilt
Street Cor- pus II	45°		-	-	Manual tilt	No tilt
C400/500 VS	Std	-	-	-	Manual tilt	No tilt
K300 PS Jr	45° Linak	45° Reac	-	-	Manual tilt	No tilt
K450 MX	Std	-	-	-	Manual tilt	No tilt
Corpus 3G	Std Corpus 3G	-	-	-	-	-
Corpus APE	Std (Linak)	-	-	-	-	-
Corpus VS	Std (Linak)	-	-	-	-	-

Legs

	Type 1	Type 2	Type 3	Type 4	Type Man	Type None
C300/C350 Corpus II	std	Right Leg , GM (for Left leg see Option 2)	-	-	Manual legs	-
C400/500 Corpus II	std	LowRider	Right Leg , GM (for Left leg see Option 2)	-	Manual legs	-
Street Cor- pus II	std	Right Leg GM (for Left leg see Option 2)	-	-	Manual legs	-
C400/500 VS	std	-	-	-	Manual legs	-
K300 PS Jr	-	-	-	-	Manual legs	-
K450 MX	-	-	-	-	Manual legs	-
Corpus 3G	std	-	-	-	Manual legs	-
Corpus APE	std	-	-	-	-	-
Corpus VS	Std	-	-	-	-	-

Backrest

	Type 1	Type 2	Type 3	Type 4	Type5	Type Man	Type None
C300/C350 Corpus II	Std, Angle switch	Spec. Adapt V-Smart-act	Spec.adapt. Angle switch	-		Manual back	-
C400/500 Corpus II	150° Side mount	120° Center mount	180° Side mount	Spec. Adapt V- Smart- act	Spec. adapt. Angle switch	Manual back	-
Street Cor- pus II	135° Side mount	Spec.adapt. angle switch	Spec. Adapt V-Smart-act	-		Manual back	-
C400/500 VS	Std (180°)	Spec. Adapt V-Smart-act	Spec.adapt. Angle switch			Manual back	-
K300 PS Jr	Spec. Adapt V-Smart-act	Spec.adapt. Angle switch	-	-		Manual back	-
K450 MX	Std Seat rotation	-	-	-		-	-
Corpus 3G	Std	Spec. Adapt V-Smart-act	Spec.adapt. Angle switch	-	-	Manual back	-
Corpus APE	Std	Spec. Adapt V-Smart-act	Spec.adapt. Angle switch	-	-	Manual back	
Corpus VS	Std	Spec. Adapt V-Smart-act	Spec.adapt. Angle switch	-	-	-	

Option 1 (Special Adaptations)

	Type 1	Type 2	Type 3	Type 4	Type Man	Type None
C300/C350 Corpus II	Right leg lift V-Smart-act	Right leg lift, GM	RA	-	-	-
C400/500 Corpus II	Right leg lift V-Smart-act	Right leg lift, GM	RA	-	-	-
Street Cor- pus II	Right leg lift V-Smart-act	Right leg lift, GM	RA	-	-	-
C400/500 VS	Right leg lift V-Smart-act	Right leg lift, GM	-	-	-	-
K300 PS Jr	Right leg lift V-Smart-act	Right leg lift, GM	RA	-	-	-
K450 MX	-	-	-	-	-	-
Corpus 3G	Right leg lift V-Smart-act	Right leg lift GM	RA	-	-	-
Corpus APE	Right leg lift V-Smart-act	Right leg lift GM	-	-	-	-
Corpus VS	Right leg lift V-Smart-act	Right leg lift GM	-	-	-	-

Option 2 (Special Adaptations)

	Type 1	Type 2	Type 3	Type 4	Type Man	Type None
C300/C350 Corpus II	Left leg V-Smart-act	Left leg GM	-	-	-	-
C400/500 Corpus II	Left leg V-Smart-act	Left leg GM	-	-	-	-
Street Cor- pus II	Left leg V-Smart-act	Left leg GM	-	-	-	-
C400/500 VS	Spec. Adapt. V-Smart-act	Left leg GM	-	-	-	-
K300 PS Jr	Left leg V-Smart-act	Left leg GM	-	-	-	-
K450 MX	-	-	-	-	-	-
Corpus 3G	Left leg V-Smart-ac	Left leg GM	-	-	-	-
Corpus APE	Left leg V-Smart-ac	Left leg GM	-	-	-	-
Corpus VS	-	-	-	-	-	-

Option 3 (Special Adaptations)

	Type 1	Type 2	Type 3	Type 4	Type Man	Type None
C300/C350 Corpus II	Spec. Adapt. V-Smart-act	Belt/Spec. Adapt, GM	Vent Tray	-	-	-
C400/500 Corpus II	Spec. Adapt. V-Smart-act	Belt/Spec. Adapt, GM	Vent Tray	-	-	-
Street Cor- pus II	Spec. Adapt. V-Smart-act	Belt/Spec. Adapt, GM	Vent Tray	-	-	-
C400/500 VS	Spec. Adapt. V-Smart-act	Belt/Spec. Adapt, GM	Vent Tray	-	-	-
K300 PS Jr	Spec. Adapt. V-Smart-act	Belt/Spec. Adapt, GM	Vent Tray	-	-	-
K450 MX	-	-	-	-	-	-
Corpus 3G	Spec. Adapt, V-Smart-act	Spec. Adapt, GM	Vent Tray	Belt	-	-
Corpus APE	Spec. Adapt, V-Smart-act	Spec. Adapt, GM	Vent Tray	Belt	-	-
Corpus VS	Spec. Adapt, V-Smart-act	Spec. Adapt, GM	Vent Tray	Belt	-	-

Option 4 (Special Adaptations)

	Type 1	Type 2	Type 3	Type 4	Type Man	Type None
C300/C350 Corpus II	Left leg lift, V-Smart-act	Left leg lift, GM	-	-	-	-
C400/500 Corpus II	Left leg lift, V-Smart-act	Left leg lift, GM	-	-	-	-
Street Cor- pus II	Left leg lift, V-Smart-act	Left leg lift, GM	-	-	-	-
C400/500 VS	N/A	N/A	N/A	N/A	N/A	N/A
K300 PS Jr	Left leg lift, V-Smart-act	Left leg lift, GM	-	-	-	-
K450 MX	-	-	-	-	-	-
Corpus 3G	Left leg lift, V-Smart-act	Left leg lift, GM	-	-	-	-
Corpus APE	-	-	-	-	-	-
Corpus VS	-	-	-	-	-	-

Articulation Legs

	Type 1	Type 2	Type 3	Type 4	Type Man	Type None
Corpus APE	Articulation legs, V-Smart-act	Left leg lift, V-Smart-act	Left leg lift, GM	-	-	-
Corpus VS	-	-	-	-	-	-

Order no. 205247-US-0

